

GENUINE
B-2
PARTS



**REPLACEMENT PARTS
FOR BRUNSWICK
A / A-2 STYLE
PINSETTERS**

**THERE'S MORE
THAN ONE WAY TO SAY
"PREMIUM B-2 PARTS".**

**FOR EXAMPLE, WE ALSO SAY
"100% MONEY-BACK
GUARANTEE,
NO QUESTIONS ASKED".**

You can be completely confident about buying replacement parts for Brunswick A/A-2 style machines from QubicaAMF. Just consider the following:

- We service the largest chain of bowling centers in the world – Our biggest customer - AMF Bowling Centers - is the largest user of replacement parts for Brunswick A/A-2 style machines in the world, operating over 8,000 lanes. These centers demand high quality, speedy delivery, and a good price - and get all three.
- We provide the best value for the money – Our B-2 parts meet or exceed their OEM specs. Many have the original made-in-the-USA design. Rigorous quality control and inspections plus “real world” testing give you added assurance.
- We stand behind our B-2 parts with the highest guarantee – And our 100% money-back, no-questions-asked guarantee proves it.

* Brunswick is a registered trademark of the Brunswick Bowling & Billiard Corporation and is in no way affiliated with QubicaAMF Worldwide, Inc.

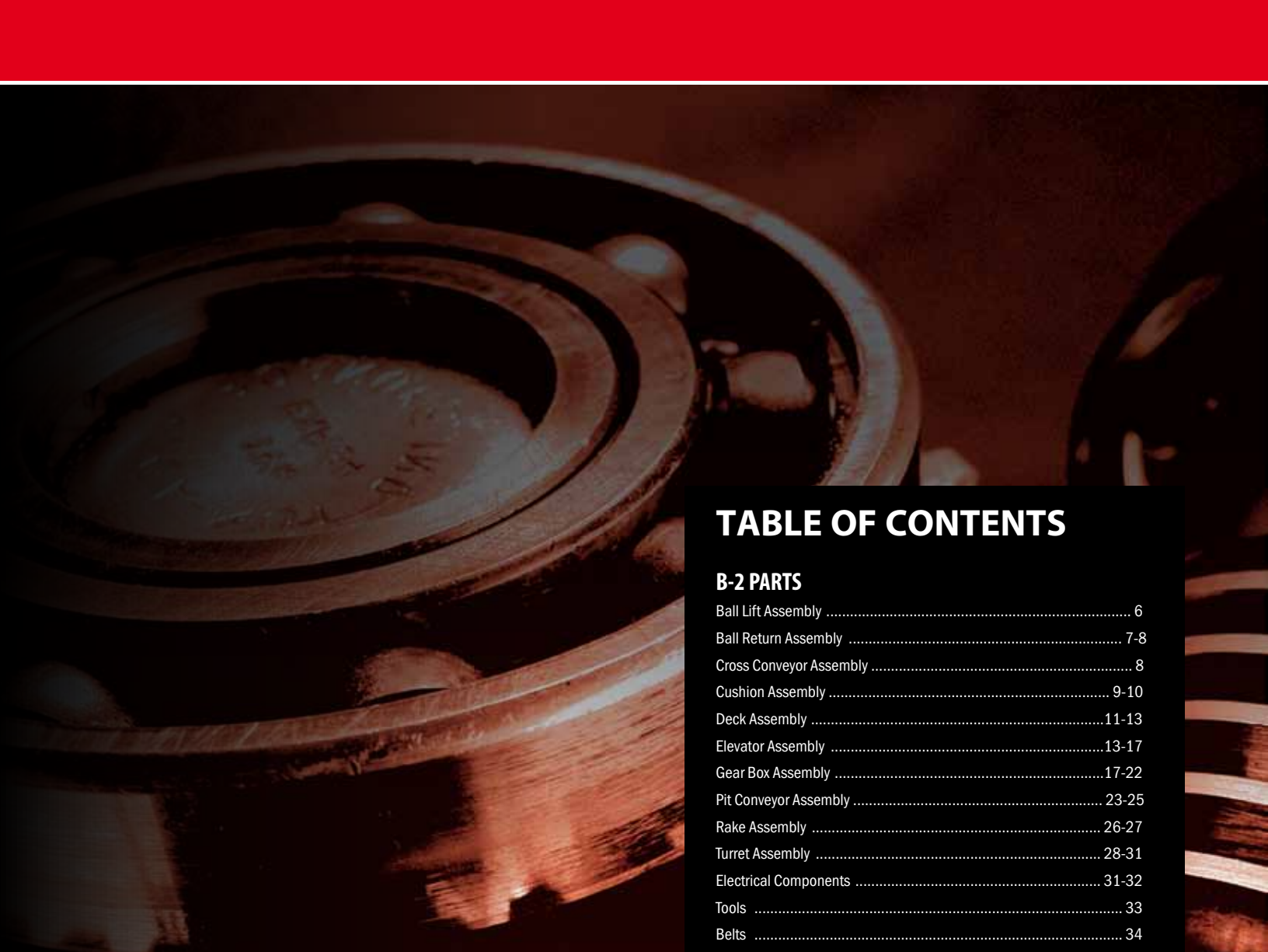

TABLE OF CONTENTS

B-2 PARTS

Ball Lift Assembly	6
Ball Return Assembly	7-8
Cross Conveyor Assembly	8
Cushion Assembly	9-10
Deck Assembly	11-13
Elevator Assembly	13-17
Gear Box Assembly	17-22
Pit Conveyor Assembly	23-25
Rake Assembly	26-27
Turret Assembly	28-31
Electrical Components	31-32
Tools	33
Belts	34

HARDWARE

Hex Head Cap Screws	38-44
Socket Head Cap Screws	45-46
Flat Head Socket Cap Screws	47-48
Button head Socket Cap Screws	49
Hex Nuts	49-51
Retaining Rings	52
Lock Washers	53
Flat Washers	54-55
Roll Pins	56
Spirol Pins	57
X-Washers	57
X-Washer Pins	58-59
Machine Keys	59
Steel Spacers & Bushings	60-61
Sleeve Oilite Bearings	62
Flanged Oilite Bearings	63
Ball Bearings	64-68
Tension Springs	69-70
Compression Springs	71



2

B - 2 HARDWARE

HEX HEAD CAP SCREWS

1/4 - 20 GRADE 2

PART	SUB-SECTION	SIZE	QUANTITY
A	B11001186001BG	1/4-20 Grade 2 1/4-20 x 1 1/4	Bag of 25
B	B11001188001BG	1/4-20 Grade 2 1/4-20 x 1 1/2	Bag of 25
C	B11001190001BG	1/4-20 Grade 2 1/4-20 x 1 3/4	Bag of 25
D	B11001192001BG	1/4-20 Grade 2 1/4-20 x 2	Bag of 25

1/4 - 20 GRADE 2 - CONTINUED

PART	SUB-SECTION	SIZE	QUANTITY
E	B11001193001BG	1/4-20 Grade 2 1/4-20 x 2 1/4	Bag of 25
F	B11001194001BG	1/4-20 Grade 2 1/4-20 x 2 1/2	Bag of 25
G	B11001195001BG	1/4-20 Grade 2 1/4-20 x 2 3/4	Bag of 25
H	B11001196001BG	1/4-20 Grade 2 1/4-20 x 3	Bag of 25

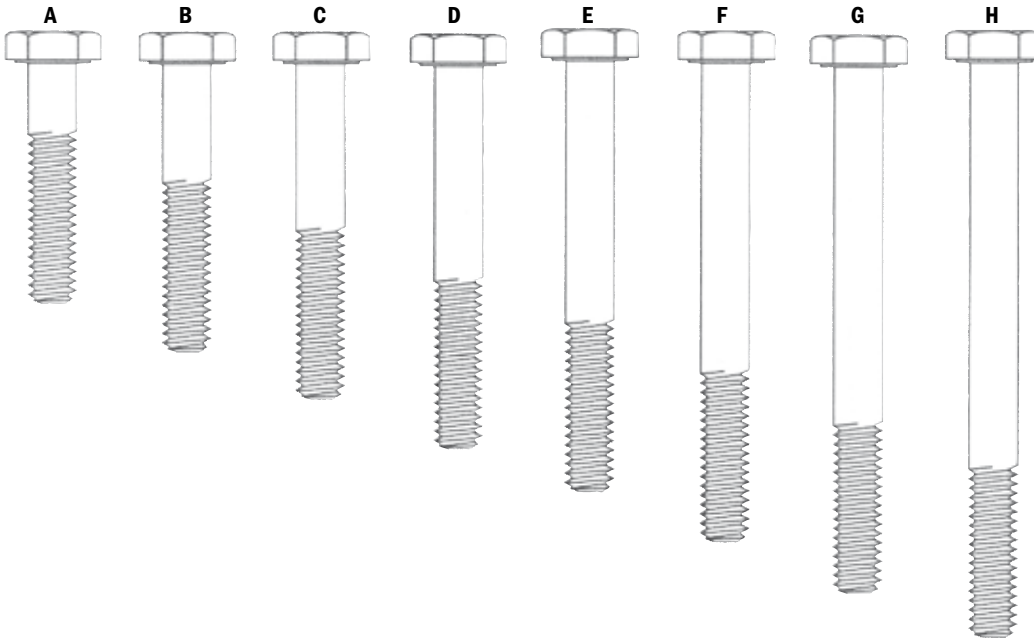

1/4 - 20 GRADE 5

PART	SUB-SECTION	SIZE	QUANTITY
A	B11002001001BG	1/4-20 Grade 5 1/4-20 x 5/8	Bag of 25
B	B11002002001BG	1/4-20 Grade 5 1/4-20 x 3/4	Bag of 25
C	B11002004001BG	1/4-20 Grade 5 1/4-20 x 1	Bag of 25
D	B11001185001BG	1/4-20 Grade 5 1/4-20 x 1 1/8	Bag of 25
E	B11002005001BG	1/4-20 Grade 5 1/4-20 x 1 1/4	Bag of 25
F	B11002006001BG	1/4-20 Grade 5 1/4-20 x 1 1/2	Bag of 25
G	B11002007001BG	1/4-20 Grade 5 1/4-20 x 1 3/4	Bag of 25
H	B11002008001BG	1/4-20 Grade 5 1/4-20 x 2	Bag of 25

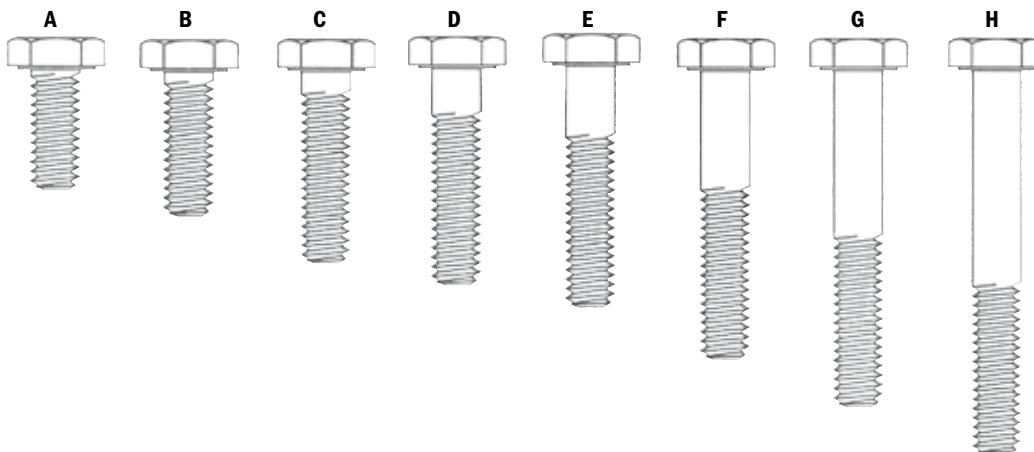

1/4 - 28 GRADE 5

PART	SUB-SECTION	SIZE	QUANTITY	
A	B11001222001BG	1/4-28 Grade 5	1/4-28 x 3/4	Bag of 25
B	B11002035001BG	1/4-28 Grade 5	1/4-28 x 1 1/4	Bag of 25

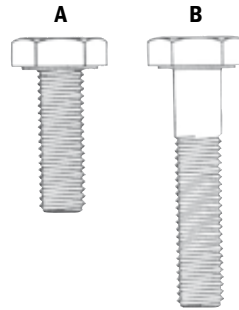

5/16 - 18 GRADE 2

PART	SUB-SECTION	SIZE	QUANTITY	
A	B11001258001BG	5/16-18 Grade 2	5/16-18 x 1/2	Bag of 25
B	B11001260001BG	5/16-18 Grade 2	5/16-18 x 5/8	Bag of 25
C	B11001262001BG	5/16-18 Grade 2	5/16-18 x 3/4	Bag of 25
D	B11001263001BG	5/16-18 Grade 2	5/16-18 x 7/8	Bag of 25
E	B11001264001BG	5/16-18 Grade 2	5/16-18 x 1	Bag of 25

5/16 - 18 GRADE 2 - CONTINUED

PART	SUB-SECTION	SIZE	QUANTITY	
F	B11001266001BG	5/16-18 Grade 2	5/16-18 x 1 1/4	Bag of 25
G	B11001268001BG	5/16-18 Grade 2	5/16-18 x 1 1/2	Bag of 25
H	B11001270001BG	5/16-18 Grade 2	5/16-18 x 1 3/4	Bag of 25
I	B11001272001BG	5/16-18 Grade 2	5/16-18 x 2	Bag of 25
J	B11001275001BG	5/16-18 Grade 2	5/16-18 x 2 3/4	Bag of 25

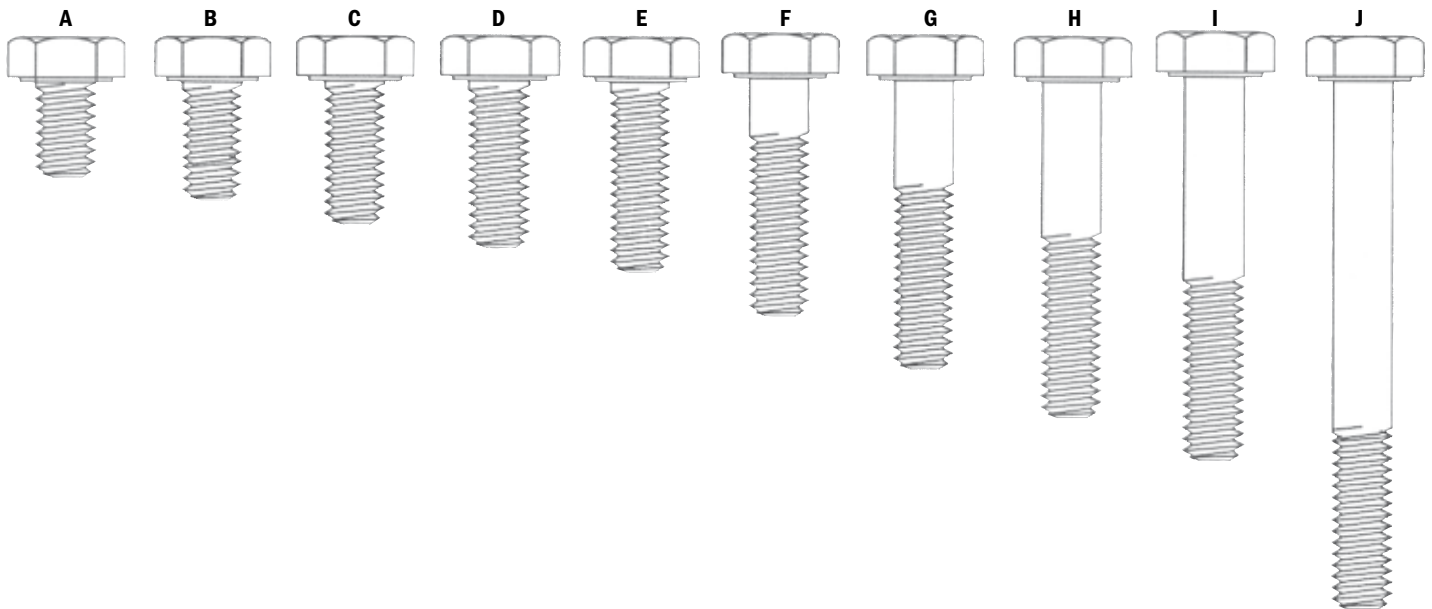

HEX HEAD CAP SCREWS - CONTINUED

5/16 - 18 GRADE 2 - CONTINUED

PART	SUB-SECTION	SIZE	QUANTITY
K	B11001276001BG	5/16-18 Grade 2 5/16-18 x 3	Bag of 25
L	B11001278001BG	5/16-18 Grade 2 5/16-18 x 3 1/2	Bag of 25
M	B11002075001BG	5/16-18 Grade 2 5/16-18 x 3 3/4	Bag of 25
N	B11001286001BG	5/16-18 Grade 2 5/16-18 x 5 1/2	Bag of 25

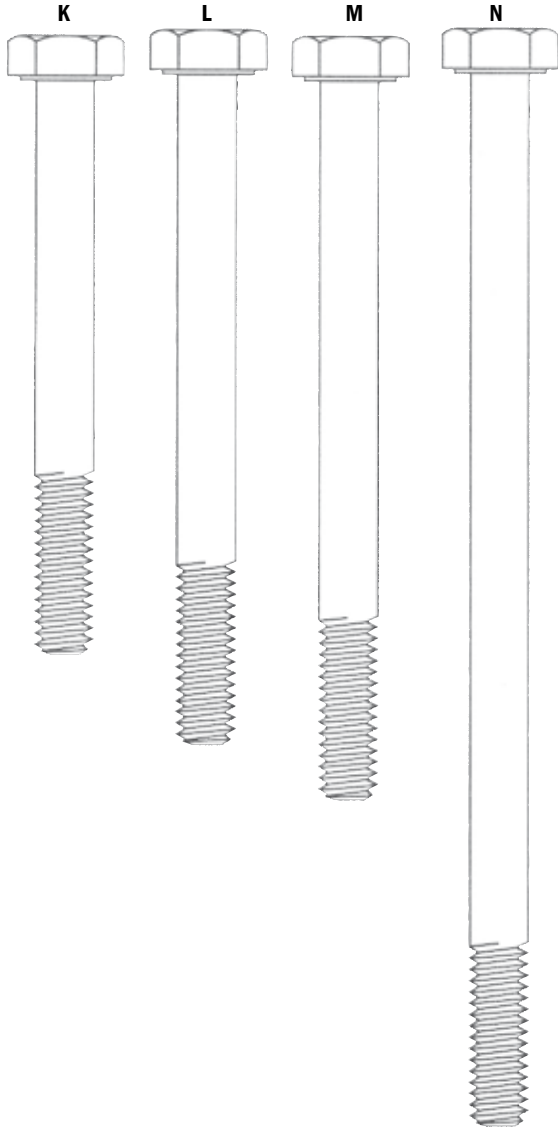

5/16 - 18 GRADE 5

PART	SUB-SECTION	SIZE	QUANTITY
A	B11001265001BG	5/16-18 Grade 5 5/16-18 x 1 1/8	Bag of 25
B	B11002068001BG	5/16-18 Grade 5 5/16-18 x 2	Bag of 25
C	B11002070001BG	5/16-18 Grade 5 5/16-18 x 2 1/2	Bag of 25

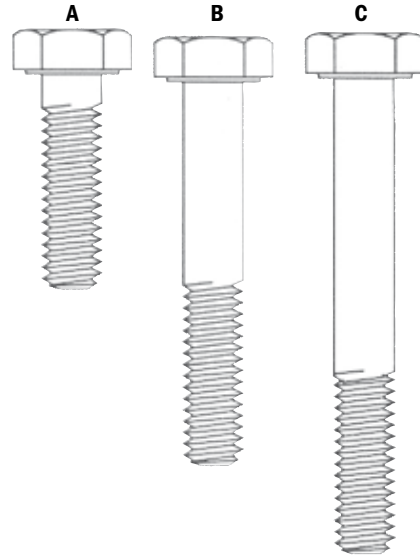

5/16 - 24 GRADE 2

PART	SUB-SECTION	SIZE	QUANTITY
A B11001304001BG	5/16-24 Grade 2	5/16-24 x 1	Bag of 25

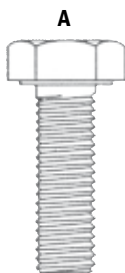

5/16 - 24 GRADE 5

PART	SUB-SECTION	SIZE	QUANTITY
A B11002092001BG	5/16-24 Grade 5	5/16-24 x 3/4	Bag of 25
B B11002094001BG	5/16-24 Grade 5	5/16-24 x 1	Bag of 25

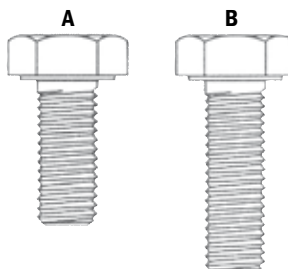

HEX HEAD CAP SCREWS - CONTINUED

3/8 - 16 GRADE 2

PART	SUB-SECTION	SIZE	QUANTITY
A	B11001342001BG	3/8-16 Grade 2 3/8-16 x 3/4	Bag of 10
B	B11001344001BG	3/8-16 Grade 2 3/8-16 x 1	Bag of 10
C	B11001346001BG	3/8-16 Grade 2 3/8-16 x 1 1/4	Bag of 10
D	B11001350001BG	3/8-16 Grade 2 3/8-16 x 1 3/4	Bag of 10
E	B11001352001BG	3/8-16 Grade 2 3/8-16 x 2	Bag of 10

3/8 - 16 GRADE 2 - CONTINUED

PART	SUB-SECTION	SIZE	QUANTITY
F	B11001353001BG	3/8-16 Grade 2 3/8-16 x 2 1/4	Bag of 10
G	B11001354001BG	3/8-16 Grade 2 3/8-16 x 2 1/2	Bag of 10
H	B11001355001BG	3/8-16 Grade 2 3/8-16 x 2 3/4	Bag of 10
I	B11001357001BG	3/8-16 Grade 2 3/8-16 x 3 1/4	Bag of 10
J	B11001359001BG	3/8-16 Grade 2 3/8-16 x 3 3/4	Bag of 10

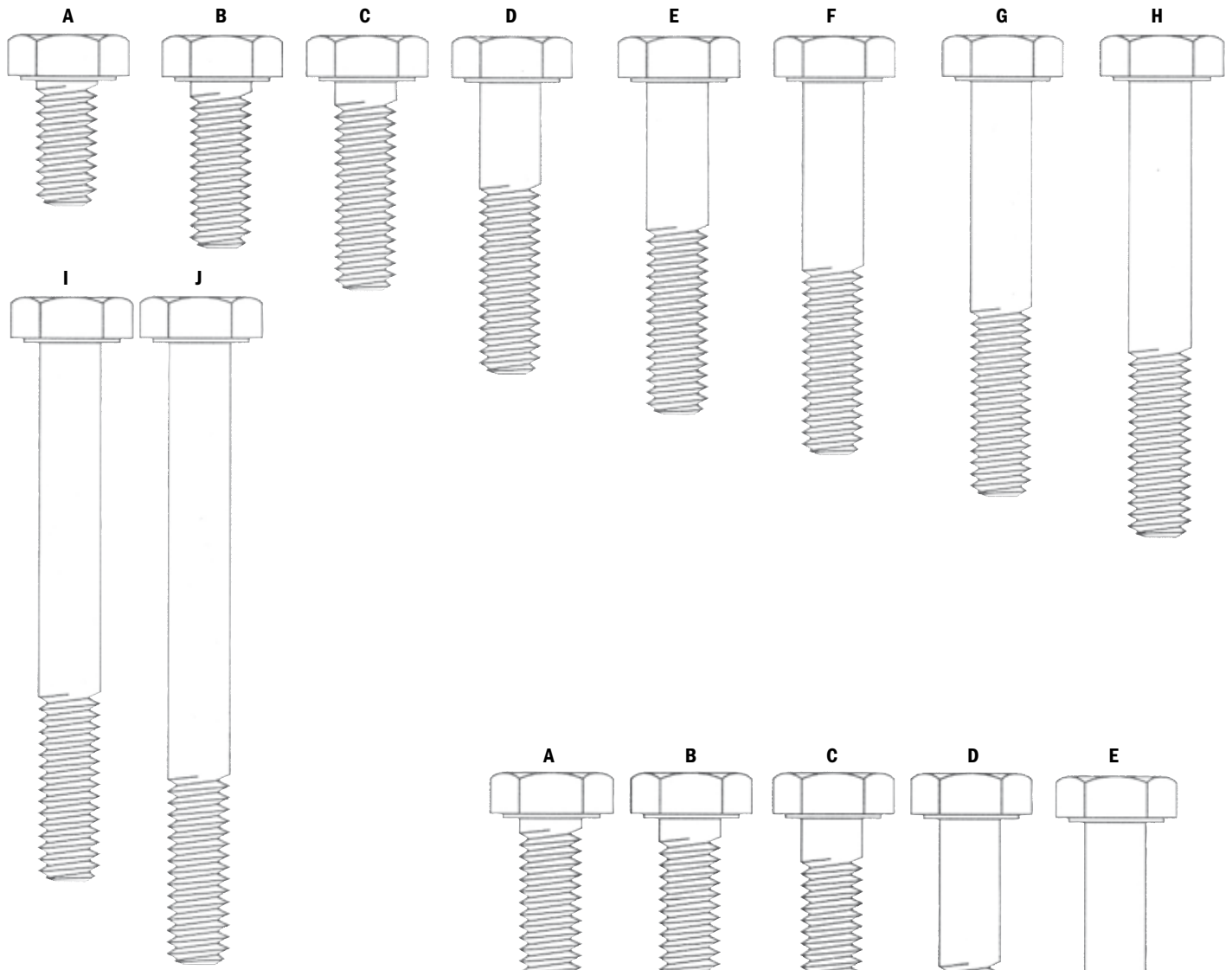

3/8 - 16 GRADE 5

PART	SUB-SECTION	SIZE	QUANTITY
A	B11002124001BG	3/8-16 Grade 5 3/8-16 x 1	Bag of 10
B	B11002125001BG	3/8-16 Grade 5 3/8-16 x 1 1/4	Bag of 10
C	B11001347001BG	3/8-16 Grade 5 3/8-16 x 1 3/8	Bag of 10
D	B11002128001BG	3/8-16 Grade 5 3/8-16 x 2	Bag of 10
E	B11002132001BG	3/8-16 Grade 5 3/8-16 x 3	Bag of 10

3/8 - 24 GRADE 2

	PART	SUB-SECTION	SIZE	QUANTITY
A	B11001384001BG	3/8-24 Grade 2	3/8-24 x 1	Bag of 10
B	B11001390001BG	3/8-24 Grade 2	3/8-24 x 1 3/4	Bag of 10
C	B11001393001BG	3/8-24 Grade 2	3/8-24 x 2 1/4	Bag of 10
D	B11001394001BG	3/8-24 Grade 2	3/8-24 x 2 1/2	Bag of 10

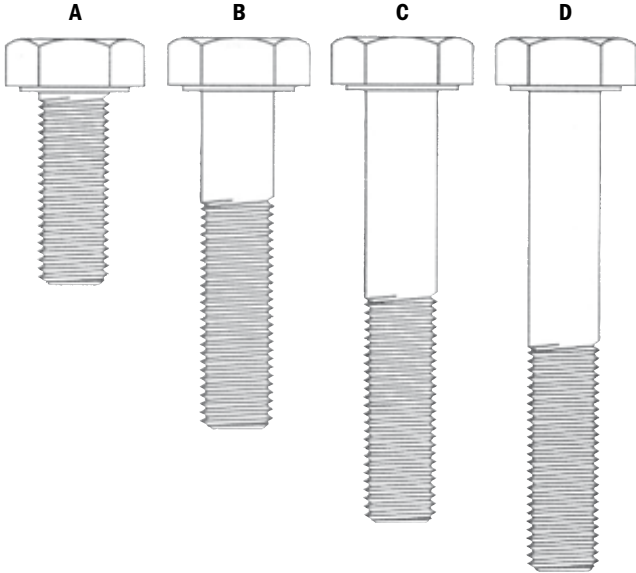

3/8 - 24 GRADE 5

	PART	SUB-SECTION	SIZE	QUANTITY
A	B11002155000BG	3/8-24 Grade 5	3/8-24 x 1 1/4	Bag of 10



HEX HEAD CAP SCREWS - CONTINUED

7/16 - 14 GRADE 5 & GRADE 2

PART	SUB-SECTION	SIZE	QUANTITY
A	B11001423001BG	7/16-14 Grade 5 7/16-14 x 7/8	Bag of 10
B	B11001436001BG	7/16-14 Grade 2 7/16-14 x 3	Bag of 10

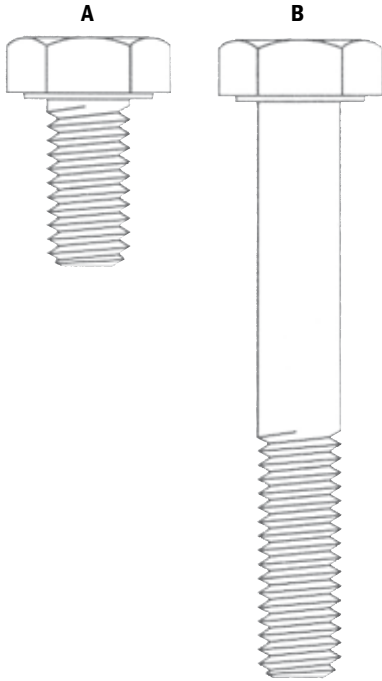

MACHINE SCREWS

PART	SUB-SECTION	SIZE	QUANTITY
A	B11001060001BG	Machine Screws #10-24 x 5/8	Bag of 25
B	B11001062001BG	Machine Screws #10-24 x 3/4	Bag of 25
C	B11001068001BG	Machine Screws #10-24 x 1 1/2	Bag of 25
D	B11001070001BG	Machine Screws #10-24 x 1 3/4	Bag of 25
E	B11001072001BG	Machine Screws #10-24 x 2	Bag of 25

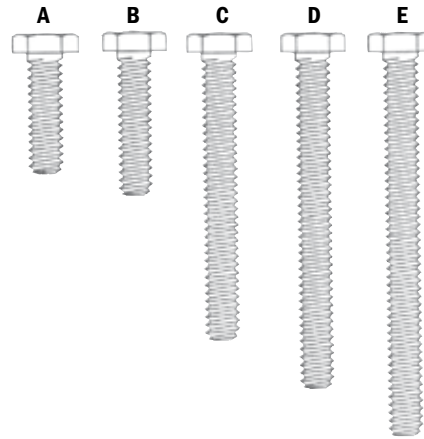

1/2 - 13 GRADE 2, 5 & 1/2 - 20 GRADE 5

PART	SUB-SECTION	SIZE	QUANTITY
A	B11001506001BG	1/2-13 Grade 2 1/2-13 x 1 1/4	Bag of 10
B	B11001508001BG	1/2-13 Grade 2 1/2-13 x 1 1/2	Bag of 10
C	B11002247000BG	1/2-13 Grade 5 1/2-13 x 1 3/4	Bag of 10
D	B10002006000BG	1/2-20 Grade 5 1/2-20 x 3 1/2	Bag of 10

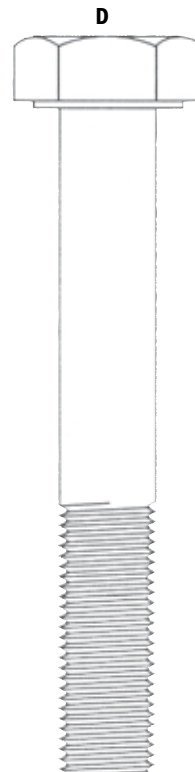
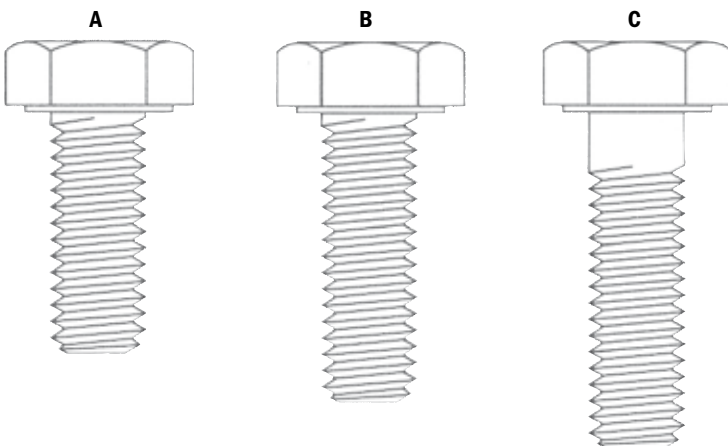

#10 - 24

PART	SUB-SECTION	SIZE	QUANTITY
A B11005092001BG	#10-24	#10-24 x 3/4	Bag of 10
B B11005093001BG	#10-24	#10-24 x 7/8	Bag of 10
C B11005094000BG	#10-24	#10-24 x 1	Bag of 10

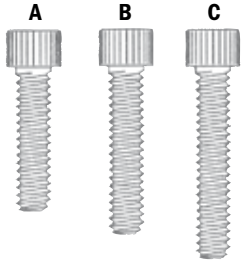

#10 - 32

PART	SUB-SECTION	SIZE	QUANTITY
A B11005118001BG	#10-32	#10-32 x 1/2	Bag of 10
B B11005120001BG	#10-32	#10-32 x 5/8	Bag of 10

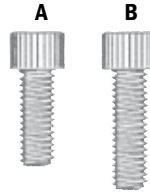

1/4 - 20

PART	SUB-SECTION	SIZE	QUANTITY
A B11005178001BG	1/4-20	1/4-20 x 1/2	Bag of 10
B B11005180001BG	1/4-20	1/4-20 x 5/8	Bag of 10
C B11005182001BG	1/4-20	1/4-20 x 3/4	Bag of 10
D B11005183001BG	1/4-20	1/4-20 x 7/8	Bag of 10
E B11005184001BG	1/4-20	1/4-20 x 1	Bag of 10
F B11005194001BG	1/4-20	1/4-20 x 2 1/2	Bag of 10

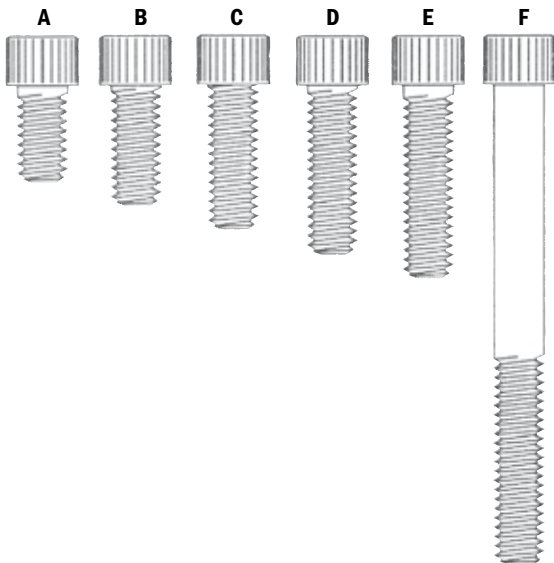

5/16 - 18

PART	SUB-SECTION	SIZE	QUANTITY
A B11005263001BG	5/16-18	5/16-18 x 7/8	Bag of 10
B B11005264001BG	5/16-18	5/16-18 x 1	Bag of 10
C B11005266001BG	5/16-18	5/16-18 x 1 1/4	Bag of 10

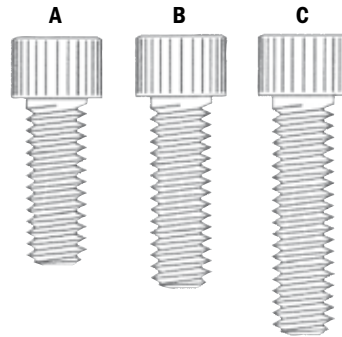

SOCKET HEAD CAP SCREWS - CONTINUED

3/8 - 16

PART	SUB-SECTION	SIZE	QUANTITY
A B11005354001BG	3/8-16	3/8-16 x 2 1/2	Bag of 10

A



3/8 - 24

PART	SUB-SECTION	SIZE	QUANTITY
A B10009001001BG	3/8-24	3/8-24 x 2	Bag of 10

A



1/2 - 20

PART	SUB-SECTION	SIZE	QUANTITY
A B11005553001BG	1/2-20	1/2-20 x 2 1/4	Bag of 10

A



FLAT HEAD SOCKET CAP SCREWS

#10 - 24

	PART	SUB-SECTION	SIZE	QUANTITY
A	B11007086001BG	#10-24	#10-24 x 3/8	Bag of 10
B	B11007090001BG	#10-24	#10-24 x 5/8	Bag of 10
C	B11007092001BG	#10-24	#10-24 x 3/4	Bag of 10
D	B11007094000BG	#10-24	#10-24 x 1	Bag of 10

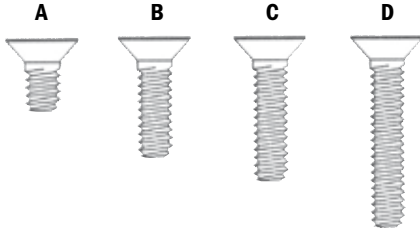

1/4 - 28

	PART	SUB-SECTION	SIZE	QUANTITY
A	B11007216001BG	1/4-28	1/4-28 x 3/8	Bag of 10

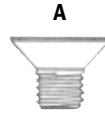

1/4 - 20

	PART	SUB-SECTION	SIZE	QUANTITY
A	B11007180001BG	1/4-20	1/4-20 x 5/8	Bag of 10
B	B11007182001BG	1/4-20	1/4-20 x 3/4	Bag of 10
C	B11007184001BG	1/4-20	1/4-20 x 1	Bag of 10
D	B11007186001BG	1/4-20	1/4-20 x 1 1/4	Bag of 10
E	B11007188001BG	1/4-20	1/4-20 x 1 1/2	Bag of 10
F	B11007195001BG	1/4-20	1/4-20 x 2 3/4	Bag of 10
G	B11007200001BG	1/4-20	1/4-20 x 4	Bag of 10

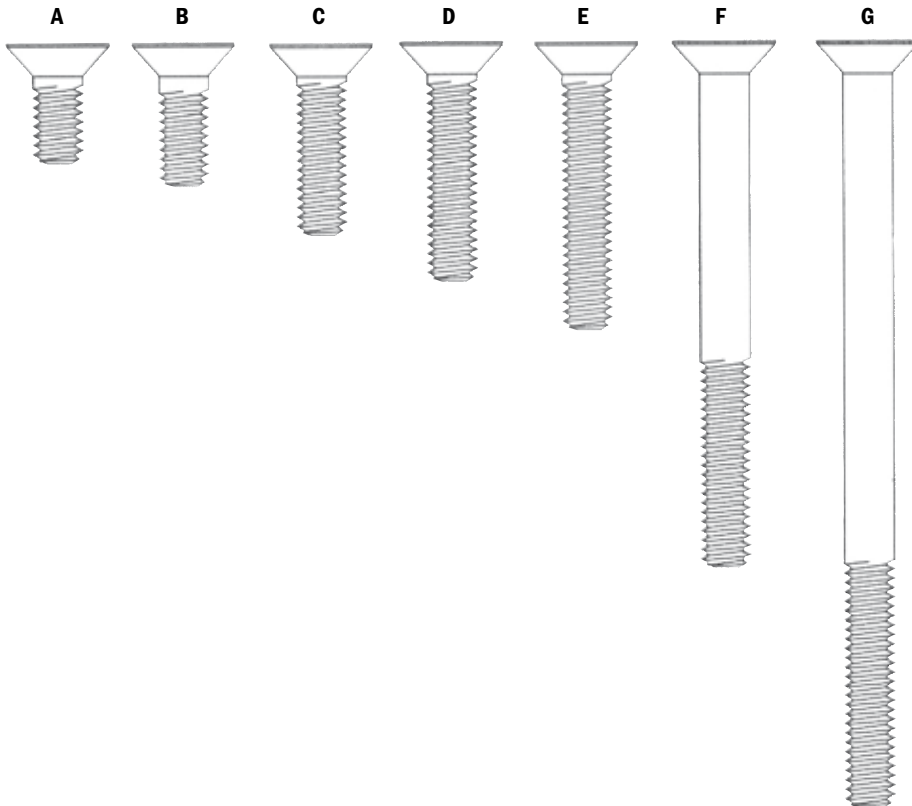

FLAT HEAD SOCKET CAP SCREWS - CONTINUED

5/16 - 18

PART	SUB-SECTION	SIZE	QUANTITY
A B11007264001BG	5/16-18	5/16-18 x 1	Bag of 10
B B11007267001BG	5/16-18	5/16-18 x 1 3/8	Bag of 10

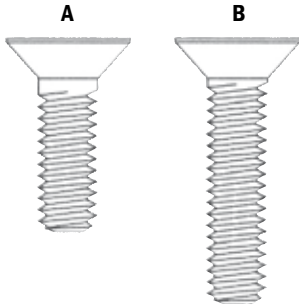

5/16 - 24

PART	SUB-SECTION	SIZE	QUANTITY
A B11007300001BG	5/16-24	5/16-24 x 5/8	Bag of 10

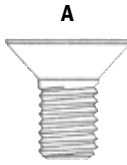

3/8 - 16

PART	SUB-SECTION	SIZE	QUANTITY
A B11007344001BG	3/8-16	3/8-16 x 1	Bag of 10
B B11007346001BG	3/8-16	3/8-16 x 1 1/4	Bag of 10
C B11007352001BG	3/8-16	3/8-16 x 2	Bag of 10

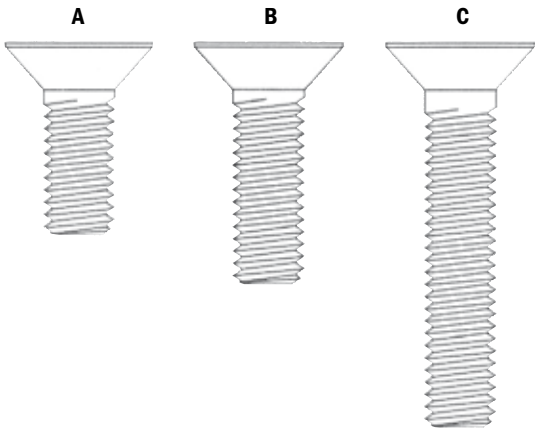

3/8 - 24

PART	SUB-SECTION	SIZE	QUANTITY
A B11007384001BG	3/8-24	3/8-24 x 1	Bag of 10
B B11007386001BG	3/8-24	3/8-24 x 1 1/4	Bag of 10
C B11007388001BG	3/8-24	3/8-24 x 1 1/2	Bag of 10

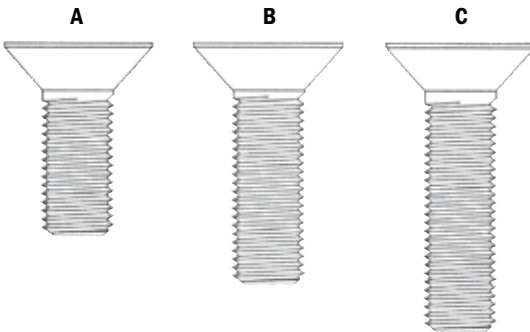

BUTTON HEAD SOCKET CAP SCREWS

#10 - 24; 1/4 - 28; 1/4 - 20; 1/2 - 13; 5/16 - 24

PART	SUB-SECTION	SIZE	QUANTITY	
A	B11006088001BG	#10-24	#10-24 x 1/2	Bag of 10
B	B11006218000BG	1/4-28	1/4-28 x 1/2	Bag of 10
C	B11006180001BG	1/4-20	1/4-20 x 5/8	Bag of 10
D	B11006184001BG	1/4-20	1/4-20 x 1	Bag of 10
E	B11006504001BG	1/2-13	1/2-13 x 1	Bag of 10
F	B11006304001BG	5/16-24	5/16-24 x 1	Bag of 10

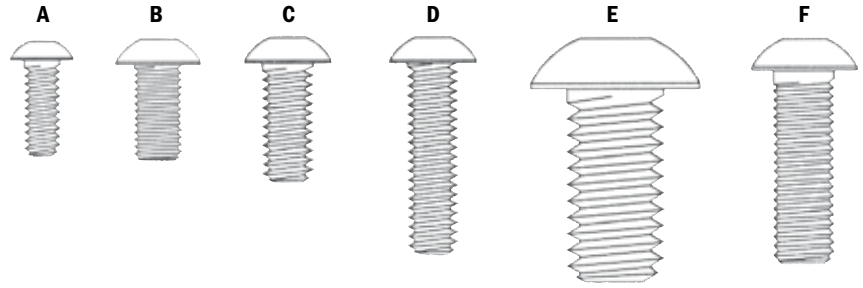

HEX NUTS

FLEXLOC

PART	SUB-SECTION	SIZE	QUANTITY	
A	B11170104001BG	FlexLoc	#10-24	Bag of 10
B	B11170106001BG	FlexLoc	1/4-20	Bag of 10
C	B11170108001BG	FlexLoc	5/16-18	Bag of 10
D	B11170109001BG	FlexLoc	5/16-24	Bag of 10
E	B11170110001BG	FlexLoc	3/8-16	Bag of 10

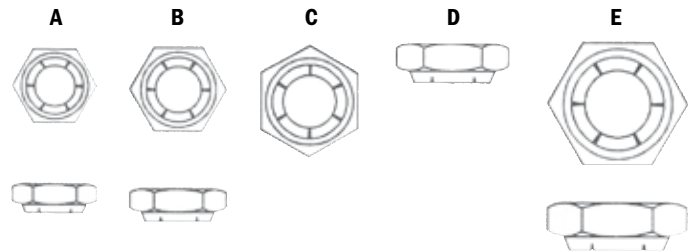

JAM NUTS

PART	SUB-SECTION	SIZE	QUANTITY	
A	B11125200001BG	Jam Nuts	1/4-20 R.H.	Bag of 25
B	B11125250001BG	Jam Nuts	1/4-20 L.H.	Bag of 10
C	B11125201001BG	Jam Nuts	1/4-28 R.H.	Bag of 25
D	B11125251001BG	Jam Nuts	1/4-28 L.H.	Bag of 10
E	B11125204001BG	Jam Nuts	3/8-16 R.H.	Bag of 25
F	B11125254001BG	Jam Nuts	3/8-16 L.H.	Bag of 10
G	B11125206001BG	Jam Nuts	7/16-14 R.H.	Bag of 25
H	B11125207001BG	Jam Nuts	7/16-20 R.H.	Bag of 25

JAM NUTS - CONTINUED

PART	SUB-SECTION	SIZE	QUANTITY	
I	B11125257000BG	Jam Nuts	7/16-20 L.H.	Bag of 10
J	B11125208001BG	Jam Nuts	1/2-13 R.H.	Bag of 25
K	B11125209001BG	Jam Nuts	1/2-20 R.H.	Bag of 25
L	B11125259001BG	Jam Nuts	1/2-20 L.H.	Bag of 10
M	B11125261000BG	Jam Nuts	9/16-18 L.H.	Bag of 10
N	B11125213001BG	Jam Nuts	5/8-18 R.H.	Bag of 25
O	B11125263001BG	Jam Nuts	5/8-18 L.H.	Bag of 10
P	B11125265001BG	Jam Nuts	3/4-16 L.H.	Bag of 10

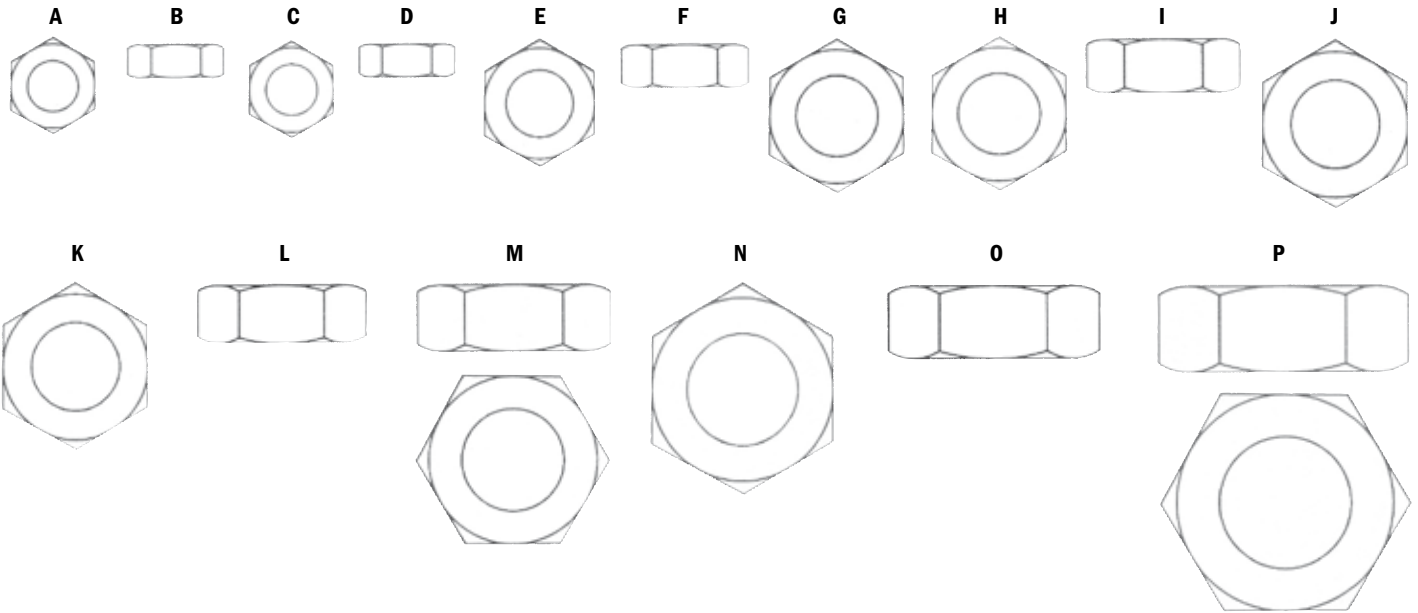

MACHINE SCREW NUTS

PART	SUB-SECTION	SIZE	QUANTITY	
A	B11125000001BG	Machine Screw Nuts	#4-40	Bag of 25
B	B11125001001BG	Machine Screw Nuts	#6-32	Bag of 25
C	B11125003001BG	Machine Screw Nuts	#8-32	Bag of 25
D	B11125004001BG	Machine Screw Nuts	#10-24	Bag of 25
E	B11125005001BG	Machine Screw Nuts	#10-32	Bag of 25

MACHINE SCREW NUTS - CONTINUED

PART	SUB-SECTION	SIZE	QUANTITY	
F	B11125006001BG	Machine Screw Nuts	#12-24	Bag of 25
G	B11125007001BG	Machine Screw Nuts	1/4-20	Bag of 25
H	B11125009001BG	Machine Screw Nuts	5/16-18	Bag of 25
I	B11125011001BG	Machine Screw Nuts	3/8-16	Bag of 25

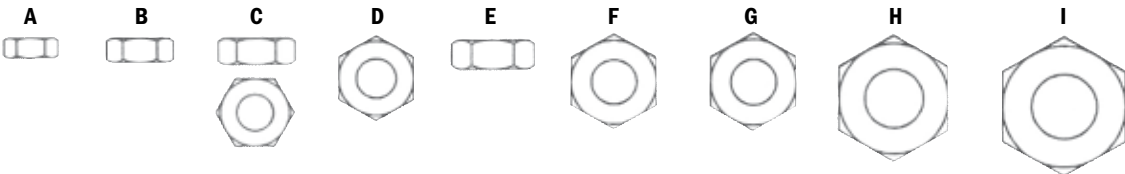

NYLOCK NUTS

PART	SUB-SECTION	SIZE	QUANTITY
A	B11170002001BG	Nylock Nuts #6-32	Bag of 25
B	B11170004001BG	Nylock Nuts #8-32	Bag of 25
C	B11170005001BG	Nylock Nuts #10-24	Bag of 25
D	B11170006001BG	Nylock Nuts #10-32	Bag of 25
E	B11170007001BG	Nylock Nuts 1/4-20	Bag of 25
F	B11170008001BG	Nylock Nuts 1/4-28	Bag of 25
G	B11170009001BG	Nylock Nuts 5/16-18	Bag of 25

PART	SUB-SECTION	SIZE	QUANTITY
H	B11170010001BG	Nylock Nuts 5/16-24	Bag of 25
I	B11170011001BG	Nylock Nuts 3/8-16	Bag of 25
J	B11170012001BG	Nylock Nuts 3/8-24	Bag of 25
K	B11170014001BG	Nylock Nuts 7/16-20	Bag of 25
L	B11170015001BG	Nylock Nuts 1/2-13	Bag of 25
M	B11170016001BG	Nylock Nuts 1/2-20	Bag of 25

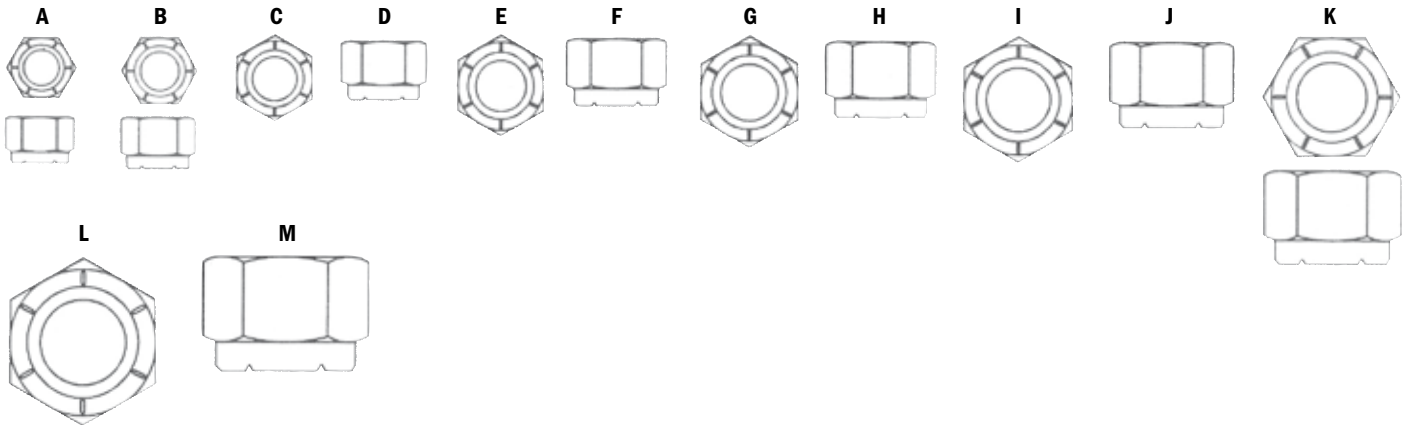

STANDARD HEX NUTS

PART	SUB-SECTION	SIZE	QUANTITY
A	B11125100001BG	Standard Hex Nuts 1/4-20	Bag of 25
B	B11125101001BG	Standard Hex Nuts 1/4-28	Bag of 25
C	B11125102001BG	Standard Hex Nuts 5/16-18	Bag of 25
D	B11125103001BG	Standard Hex Nuts 5/16-24	Bag of 25
E	B11125104001BG	Standard Hex Nuts 3/8-16	Bag of 25

STANDARD HEX NUTS - CONTINUED

PART	SUB-SECTION	SIZE	QUANTITY
F	B11125106001BG	Standard Hex Nuts 7/16-14	Bag of 25
G	B11125107001BG	Standard Hex Nuts 7/16-20	Bag of 25
H	B11125108001BG	Standard Hex Nuts 1/2-13	Bag of 25
I	B11125109001BG	Standard Hex Nuts 1/2-20	Bag of 25
J	B11125115001BG	Standard Hex Nuts 3/4-16	Bag of 25

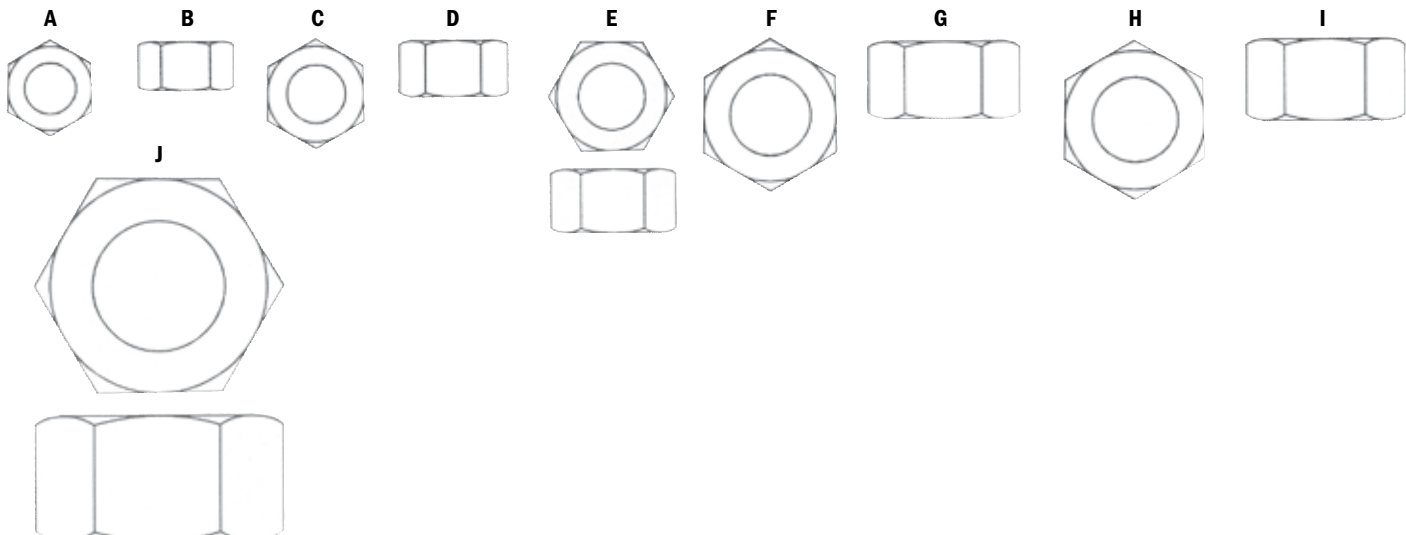

RETAINING RINGS

EXTERNAL

PART	SUB-SECTION	SIZE	QUANTITY
A	B11530012001BG	External	Bag of 20
B	B11530015001BG	External	Bag of 20
C	B11530017001BG	External	Bag of 20
D	B11530019001BG	External	Bag of 20
E	B11530021001BG	External	Bag of 20

EXTERNAL & EXTERNAL SPIROL - CONTINUED

PART	SUB-SECTION	SIZE	QUANTITY
F	B11530025001BG	External	Bag of 20
G	B11530027001BG	External	Bag of 20
H	B11530028001BG	External	Bag of 20
I	B11530030001BG	External	Bag of 20
J	B11533512001BG	External Spirol	Bag of 20

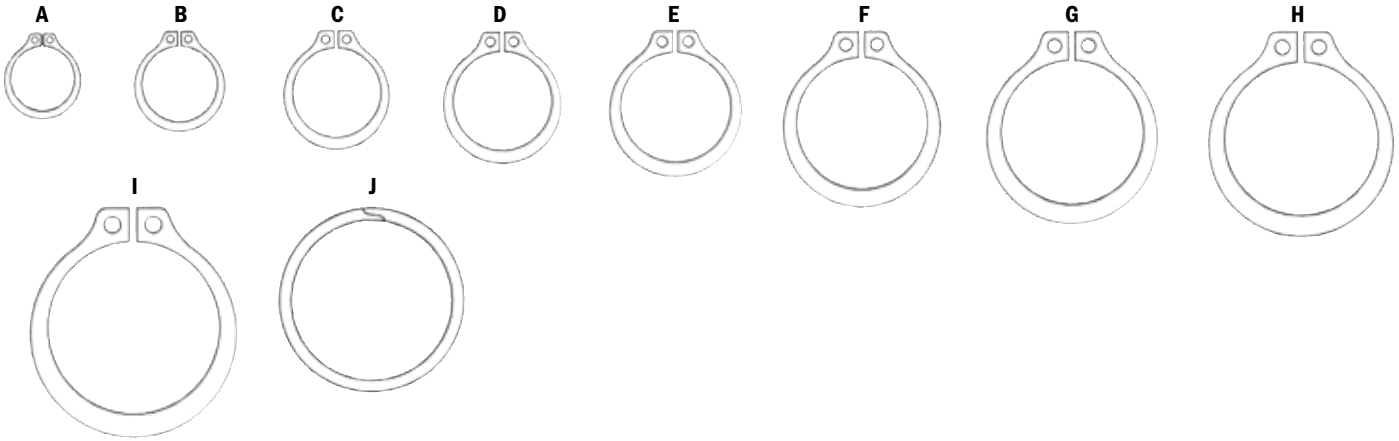

INTERNAL & INTERNAL SPIROL

PART	SUB-SECTION	SIZE	QUANTITY
A	B11536026001BG	Internal Spirol	Bag of 20

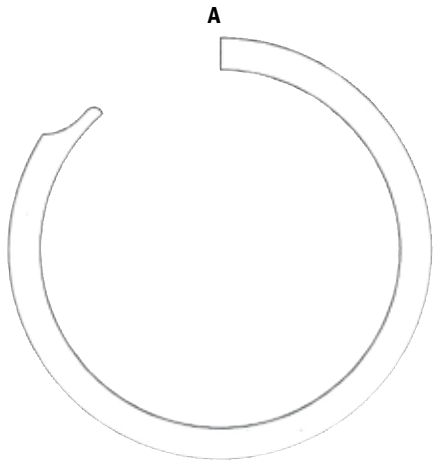

EXTERNAL TOOTH

	PART	SUB-SECTION	SIZE	QUANTITY
A	B11198002001BG	External Tooth	#8	Bag of 25
B	B11198003001BG	External Tooth	#10	Bag of 25
C	B11198005001BG	External Tooth	1/4	Bag of 25
D	B11198007001BG	External Tooth	3/8	Bag of 25
E	B11198009001BG	External Tooth	1/2	Bag of 25

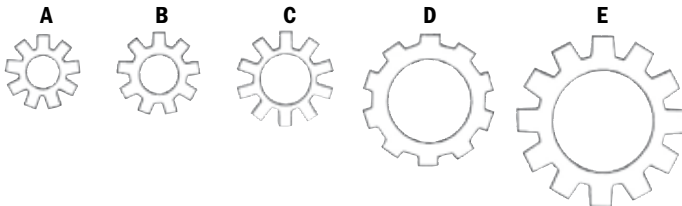

HI-COLLAR SPLIT

	PART	SUB-SECTION	SIZE	QUANTITY
A	B11196008001BG	Hi-Collar Split	#10	Bag of 25
B	B11196020001BG	Hi-Collar Split	1/2	Bag of 25

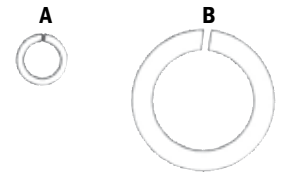

SPLIT

	PART	SUB-SECTION	SIZE	QUANTITY
A	B11195004001BG	Split	#4	Bag of 25
B	B11195006001BG	Split	#6	Bag of 25
C	B11195008001BG	Split	#8	Bag of 25
D	B11195010001BG	Split	#10	Bag of 25
E	B11195014001BG	Split	1/4	Bag of 25

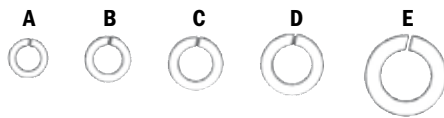

SPLIT - CONTINUED

	PART	SUB-SECTION	SIZE	QUANTITY
F	B11195015001BG	Split	5/16	Bag of 25
G	B11195016001BG	Split	3/8	Bag of 25
H	B11195017001BG	Split	7/16	Bag of 25
I	B11195018001BG	Split	1/2	Bag of 25
J	B11195020001BG	Split	5/8	Bag of 25

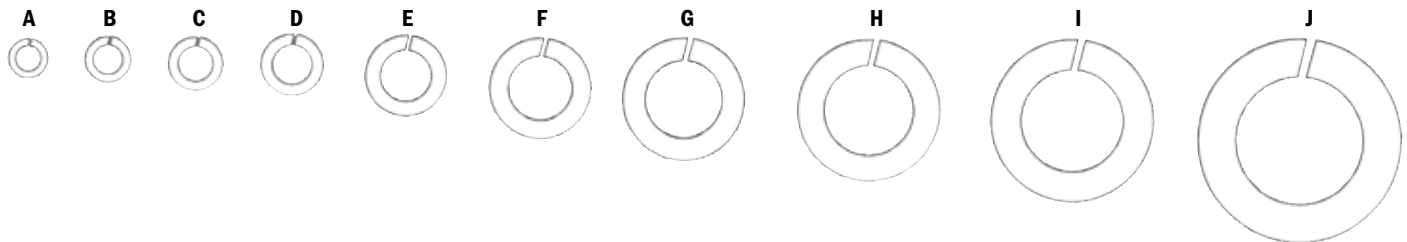

FLAT WASHERS

NON - STANDARD			
PART	SUB-SECTION	SIZE	QUANTITY
A	B10191557000BG	Non-Standard	Bag of 25
B	B11190509001BG	Non-Standard	Bag of 25
C	B11190511001BG	Non-Standard	Bag of 25
D	B11190512001BG	Non-Standard	Bag of 25
E	B11190514001BG	Non-Standard	Bag of 25
F	B11190515001BG	Non-Standard	Bag of 25

NON - STANDARD - CONTINUED			
PART	SUB-SECTION	SIZE	QUANTITY
G	B11190519001BG	Non-Standard	Bag of 25
H	B11190520001BG	Non-Standard	Bag of 25
I	B11190521001BG	Non-Standard	Bag of 25
J	B11190522001BG	Non-Standard	Bag of 25
K	B11190527001BG	Non-Standard	Bag of 25

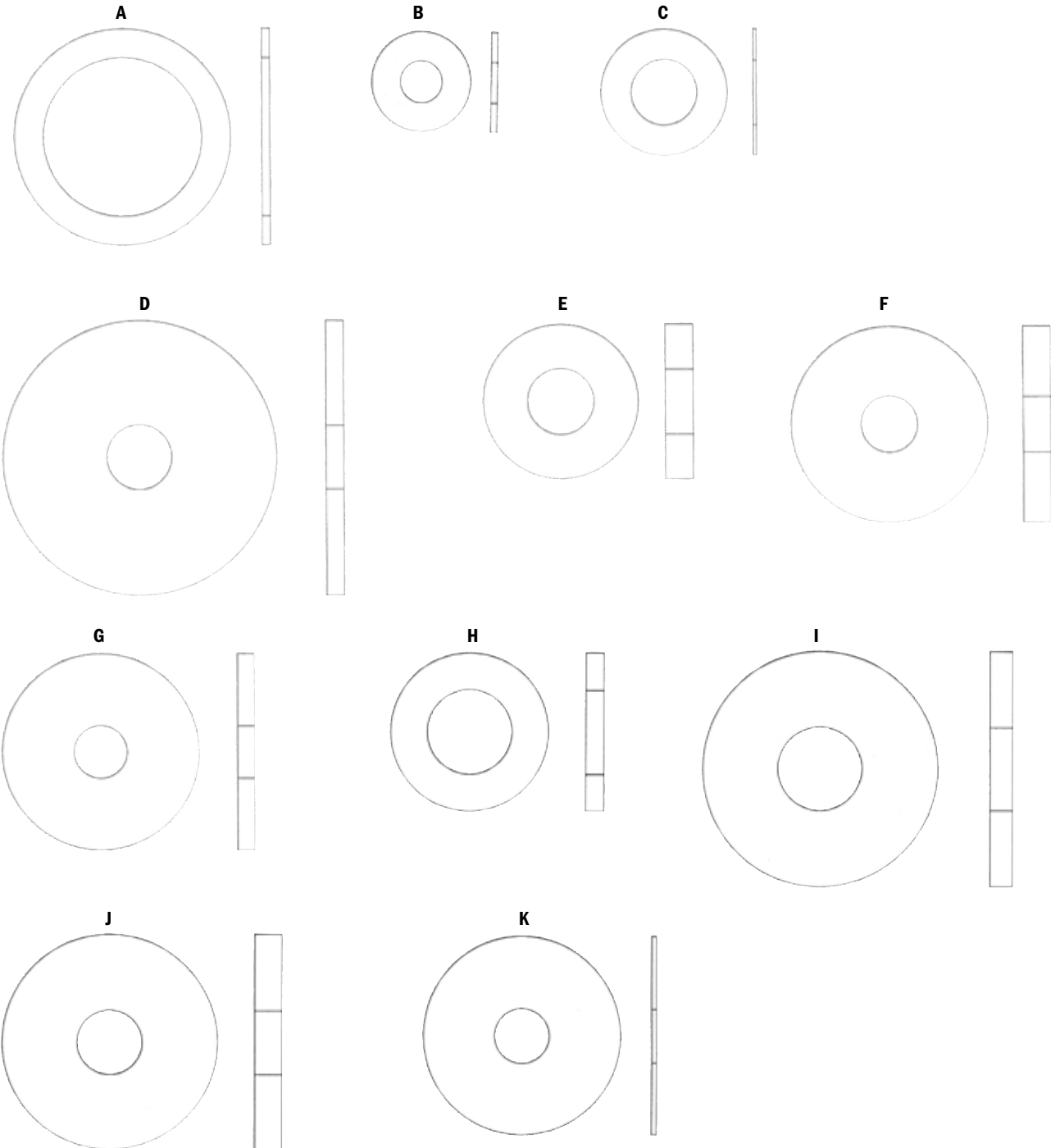

SAE				
PART	SUB-SECTION	SIZE	QUANTITY	
A	B11190002001BG	SAE #6	Bag of 25	
B	B11190004001BG	SAE #8	Bag of 25	
C	B11190006001BG	SAE #10	Bag of 25	
D	B11190010001BG	SAE 1/4	Bag of 25	
E	B11190012001BG	SAE 5/16	Bag of 25	

SAE- CONTINUED				
PART	SUB-SECTION	SIZE	QUANTITY	
F	B11190014001BG	SAE 3/8	Bag of 25	
G	B11190016001BG	SAE 7/16	Bag of 25	
H	B11190018001BG	SAE 1/2	Bag of 25	
I	B11190022001BG	SAE 5/8	Bag of 25	

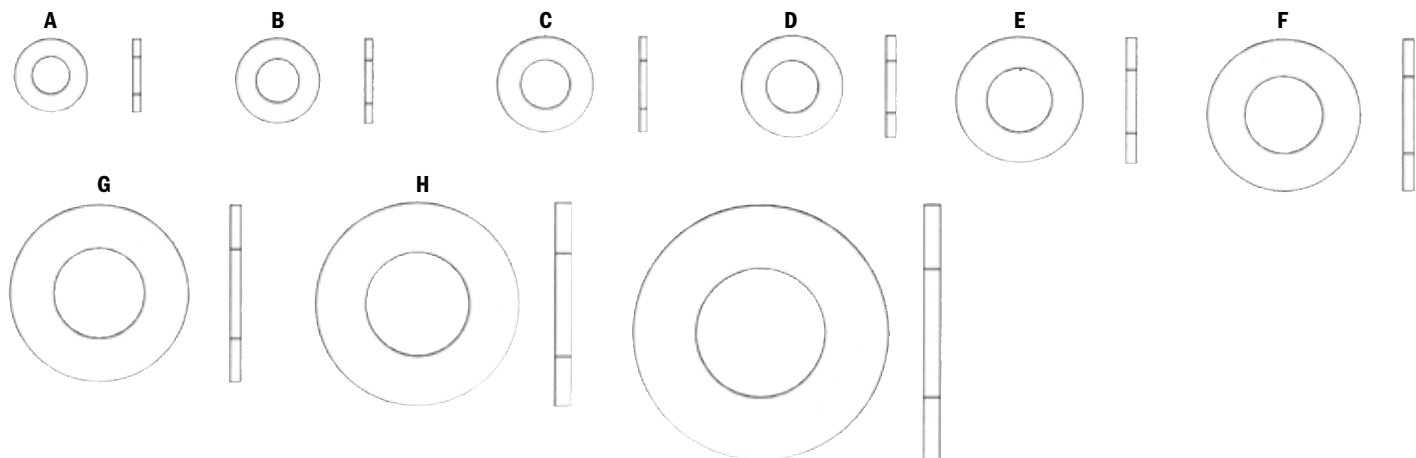

USS				
PART	SUB-SECTION	SIZE	QUANTITY	
A	B11191014001BG	USS 3/8	Bag of 25	
B	B11191024001BG	USS 3/4	Bag of 25	
C	B11191018001BG	USS 1/2	Bag of 25	

SPECIALIZED				
PART	SUB-SECTION	SIZE	QUANTITY	
A	B12250076002BG	Specialized Fiber Washer	Bag of 25	
B	B12252360000BG	Specialized D Washer	Bag of 5	

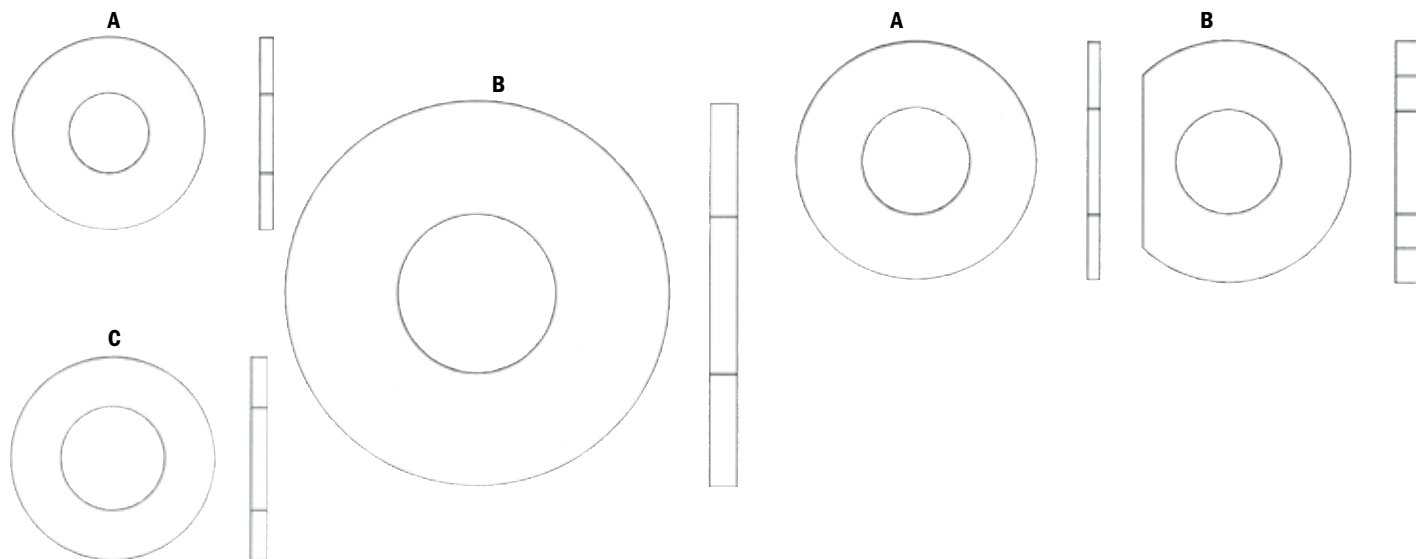

ROLL PINS

ROLL PINS			
PART	SIZE	QUANTITY	
A	B11345154000BG	1/8 x 1/2	Bag of 20
B	B11345160001BG	1/8 x 7/8	Bag of 20
C	B11345161001BG	1/8 x 15/16	Bag of 20
D	B11345258001BG	5/32 x 3/4	Bag of 20
E	B11345264000BG	5/32 x 1 1/4	Bag of 20
F	B11345302001BG	3/16 x 3/8	Bag of 20
G	B11345304000BG	3/16 x 1/2	Bag of 20
H	B11345306000BG	3/16 x 5/8	Bag of 20
I	B11345312000BG	3/16 x 1	Bag of 20
J	B11345318000BG	3/16 x 1 3/4	Bag of 20

ROLL PINS - CONTINUED			
PART	SIZE	QUANTITY	
L	B11345404000BG	1/4 x 1/2	Bag of 20
M	B11345406000BG	1/4 x 5/8	Bag of 20
N	B11345408001BG	1/4 x 3/4	Bag of 20
O	B11345412000BG	1/4 x 1	Bag of 20
P	B11345418001BG	1/4 x 1 3/4	Bag of 20
Q	B11345420001BG	1/4 x 2	Bag of 20
R	B11345516000BG	3/8 x 1 1/2	Bag of 20
S	B11345520001BG	3/8 x 2	Bag of 20
T	B11345573000BG	1/2 x 2 3/4	Bag of 20

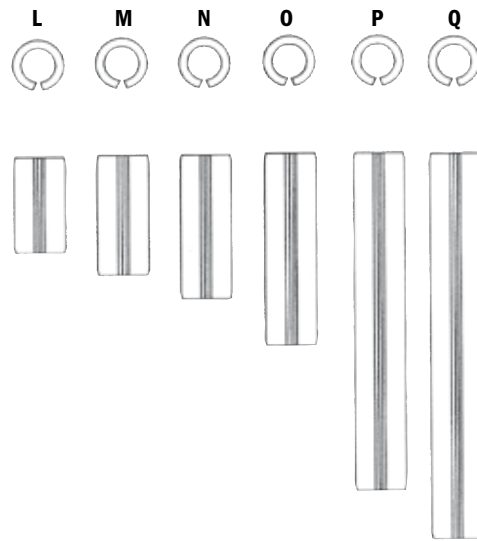
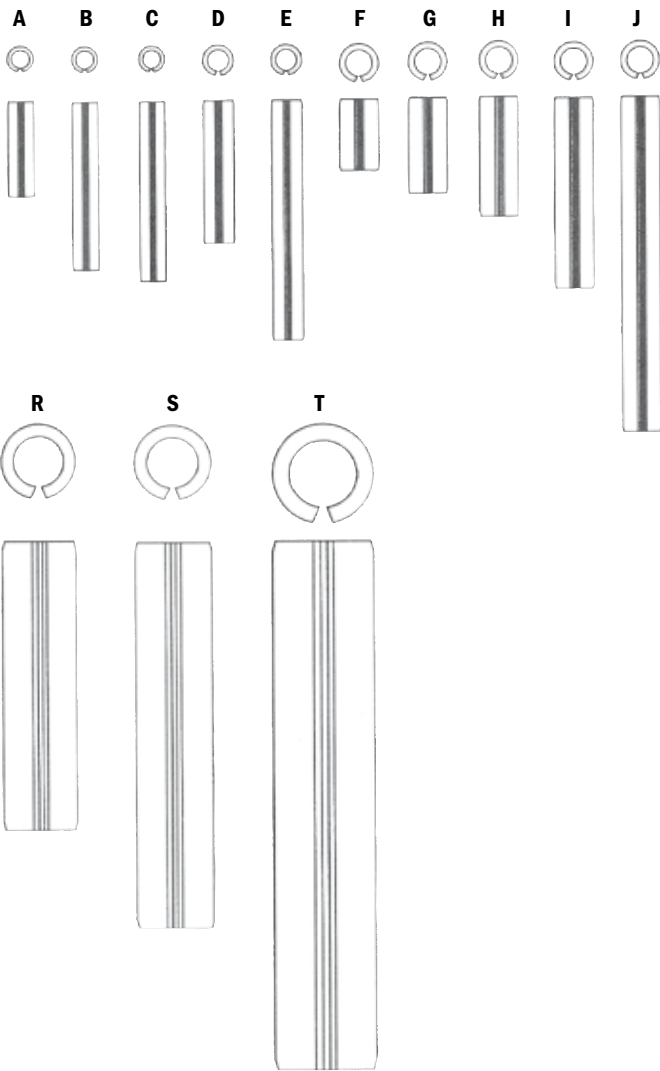

SPIROL PINS

	PART	SIZE	QUANTITY
A	B11360257000BG	3/32 x 9/16	Bag of 20
B	B11360258001BG	3/32 x 5/8	Bag of 20
C	B11360260000BG	3/32 x 3/4	Bag of 20
D	B11360264000BG	3/32 x 1	Bag of 20
E	B11360365001BG	1/8 x 1 1/8	Bag of 20

SPIROL PINS - CONTINUED

	PART	SIZE	QUANTITY
F	B11360460000BG	3/16 x 3/4	Bag of 20
G	B11360465000BG	3/16 x 1 1/8	Bag of 20
H	B11360466000BG	3/16 x 1 1/4	Bag of 20
I	B11361315000BG	3/16 x 1 3/8	Bag of 20
J	B11360619000BG	5/16 x 1 5/8	Bag of 20

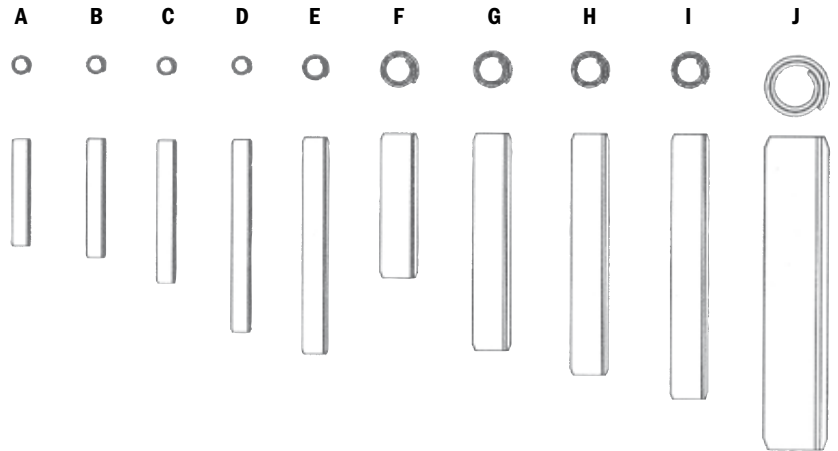

X-WASHERS

X-WASHERS

	PART	QUANTITY
A	B11230000001BG	Bag of 25
B	B11230001001BG	Bag of 25
C	B11230002001BG	Bag of 25
D	B11230003001BG	Bag of 25
E	B11230005001BG	Bag of 25

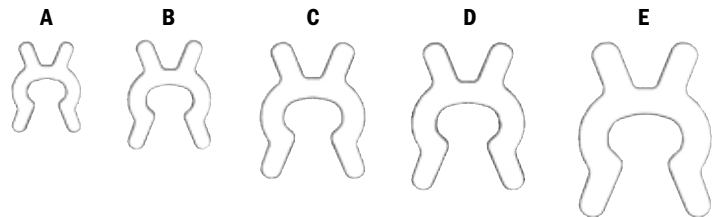

X-WASHER PINS

X-WASHER PINS

	PART	QUANTITY
A	B12100166002BG	Bag of 5
B	B12100166004BG	Bag of 5
C	B12100166005BG	Bag of 5
D	B12150158013BG	Bag of 5
E	B12100166006BG	Bag of 5
F	B12100166024BG	Bag of 5
G	B12100166022BG	Bag of 5
H	B12100166008BG	Bag of 5

X-WASHER PINS - CONTINUED

	PART	QUANTITY
I	B12100166026BG	Bag of 5
J	B12100166025BG	Bag of 5
K	B12150158007BG	Bag of 5
L	B12150158006BG	Bag of 5
M	B12150158012BG	Bag of 5
N	B12100166019BG	Bag of 5
O	B12100166009BG	Bag of 5
P	B12100166011BG	Bag of 5

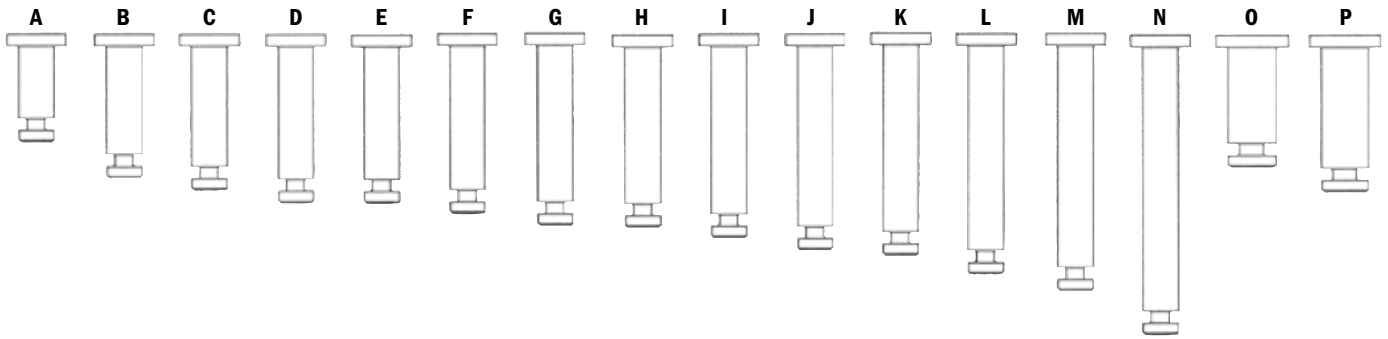

X-WASHER PINS - CONTINUED

	PART	QUANTITY
Q	B12250010011BG	Bag of 5
R	B12100166027BG	Bag of 5
S	B12100166007BG	Bag of 5
T	B12100166013BG	Bag of 5
U	B12100166014BG	Bag of 5
V	B12100166015BG	Bag of 5
W	B12150158015BG	Bag of 5

X-WASHER PINS - CONTINUED

	PART	QUANTITY
X	B12100166016BG	Bag of 5
Y	B12100166017BG	Bag of 5
Z	B12100166032BG	Bag of 5
AA	B12150158017BG	Bag of 5
BB	B12150158014BG	Bag of 2
CC	B12150158016BG	Bag of 2
DD	B12150023007BG	Bag of 5

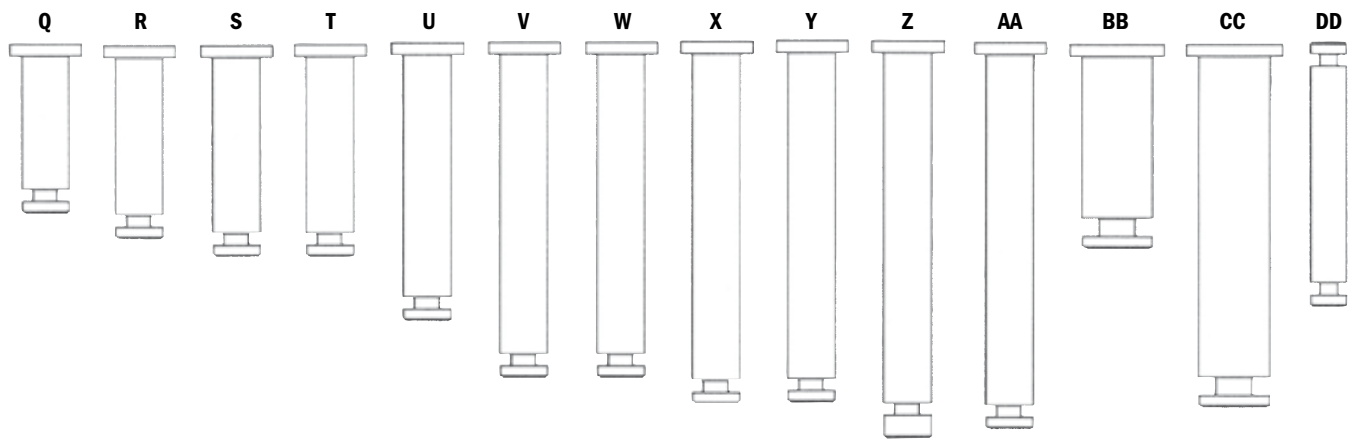

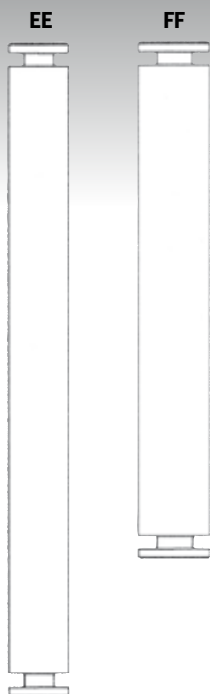

X-WASHER PINS - CONTINUED

	PART	QUANTITY
EE	B12450006002BG	Bag of 5
FF	B12150023002BG	Bag of 5

MACHINE KEYS

MACHINE KEYS (Left Section)

	PART	SIZE	QUANTITY
A	B12100164000BG	Rectangular	Bag of 5
B	B12400138008BG	Rectantular	Bag of 5

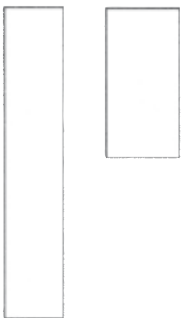

MACHINE KEYS (Right Section)

	PART	SIZE	QUANTITY
A	B12100187009BG	Square	Bag of 5
B	B12400138007BG	Square	Bag of 5
C	B12400138002BG	Square	Bag of 5
D	B12400138006BG	Square	Bag of 5
E	B12400138004BG	Square	Bag of 5
F	B12100187011BG	Square	Bag of 5
G	B12400138003BG	Square	Bag of 5

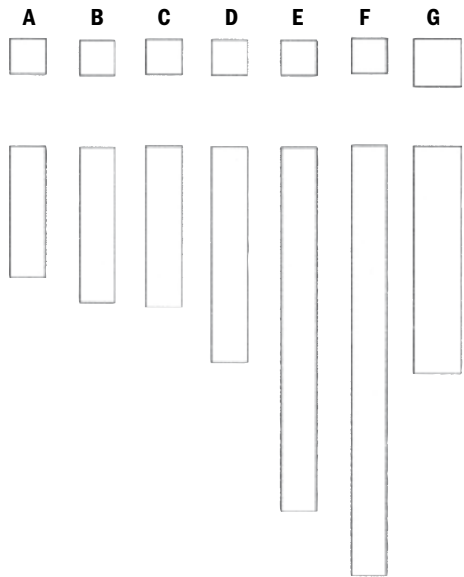

STEEL SPACERS & BUSHINGS

STEEL SPACERS & BUSHINGS

PART	QUANTITY
A B12100185021BG	Bag of 2
B B12100030005BG	Bag of 2
C B12100030002BG	Bag of 2
D B10386062000BG	Bag of 2
E B12100185022BG	Bag of 2
F B12250183005BG	Bag of 2
G B12200047003BG	Bag of 2
H B12100896000BG	Bag of 2
I B12250011012BG	Bag of 2
J B12400018005BG	Bag of 2
K B12400018004BG	Bag of 2

STEEL SPACERS & BUSHINGS - CONTINUED

PART	QUANTITY
L B12250011003BG	Bag of 2
M B12250011021BG	Bag of 2
N B12250011020BG	Bag of 2
O B12250011014BG	Bag of 2
P B12250011011BG	Bag of 2
Q B12250011019BG	Bag of 2
R B12150125000BG	Bag of 2
S B12100185020BG	Bag of 2
T B12252349000BG	Bag of 2
U B12100185023BG	Bag of 2
V B12250011002BG	Bag of 2

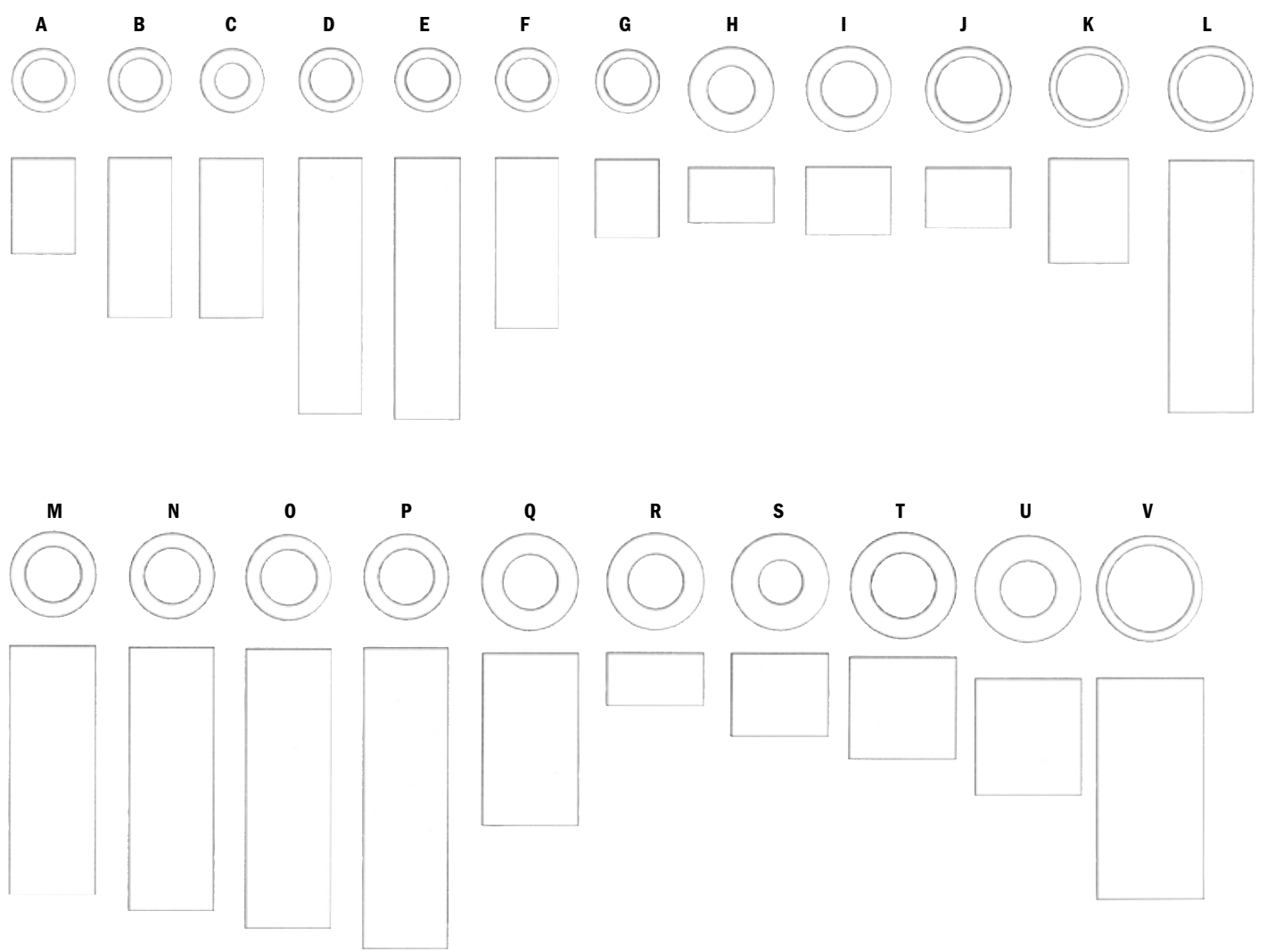

STEEL SPACERS & BUSHINGS - CONTINUED

PART	QUANTITY
W B12400018023BG	Bag of 2
X B12400018008BG	Bag of 2
Y B10386092000BG	Bag of 2
Z B12100185036BG	Bag of 2
AA B12252350000BG	Bag of 2

STEEL SPACERS & BUSHINGS - CONTINUED

PART	QUANTITY
BB B12400018007BG	Bag of 2
CC B12400018002BG	Bag of 2
DD B12150217000	Qty. 1
EE B12400289000	Qty. 1
FF B12150267000BG	Bag of 2
GG B112200047003BG	Bag of 2

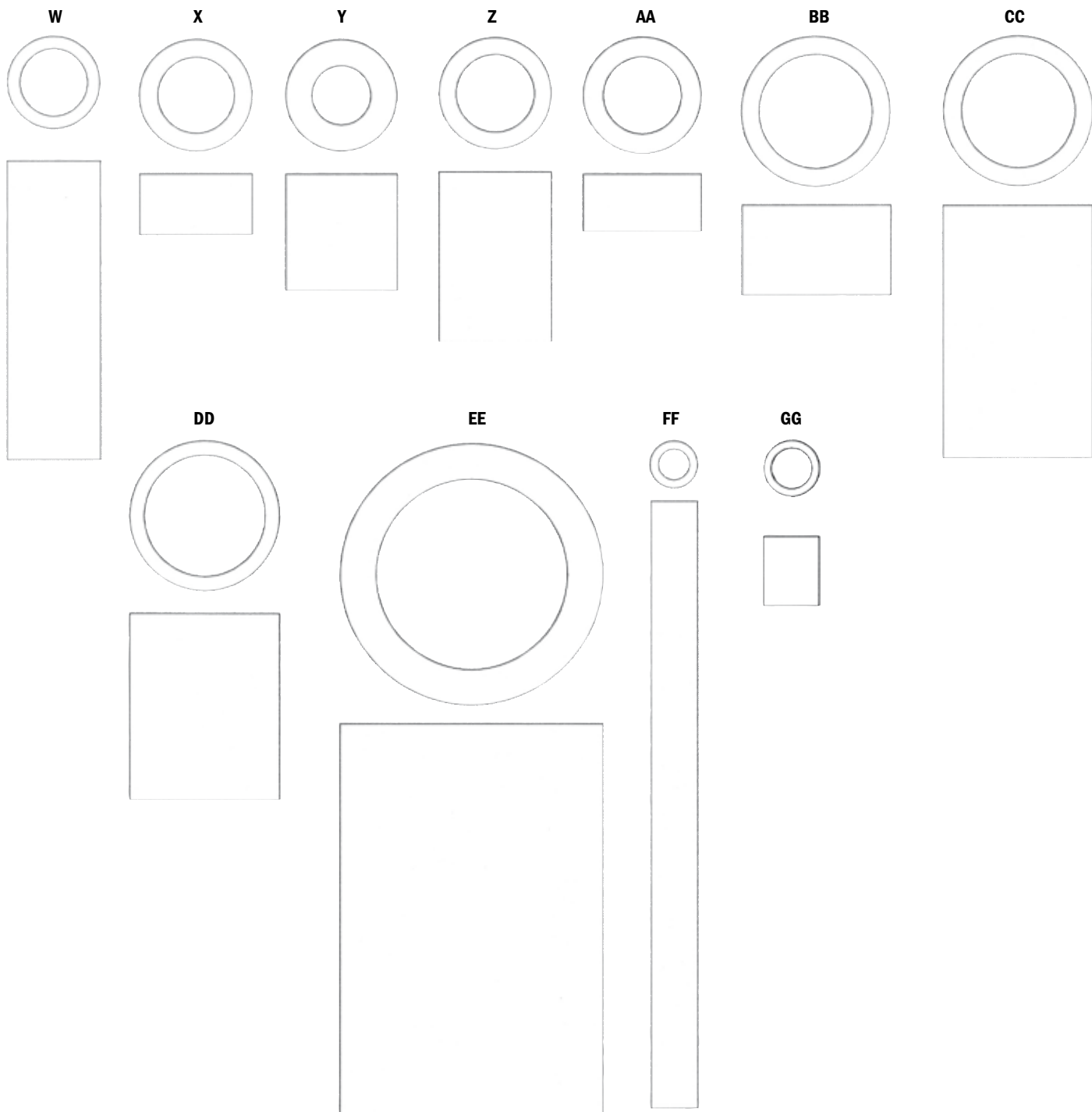

SLEEVE OILITE BEARINGS

SLEEVE OILITE BEARINGS

PART	QUANTITY
A B1142000000BG	Bag of 5
B B12150190000BG	Bag of 5
C B11420043000BG	Bag of 5
D B11423000000BG	Bag of 5
E B11420007000BG	Bag of 5
F B11420097000BG	Bag of 5
G B12250091000BG	Bag of 5
H B11420008000BG	Bag of 5
I B12100334000BG	Bag of 5

SLEEVE OILITE BEARINGS - CONTINUED

PART	QUANTITY
J B11420009000BG	Bag of 5
K B11420015000BG	Bag of 5
L B11420095000BG	Bag of 5
M B12250075000BG	Bag of 5
N B11420102000BG	Bag of 5
O B11420094000BG	Bag of 5
P B11420019000BG	Bag of 5
Q B10424001000BG	Bag of 2
R B11420054000BG	Bag of 5

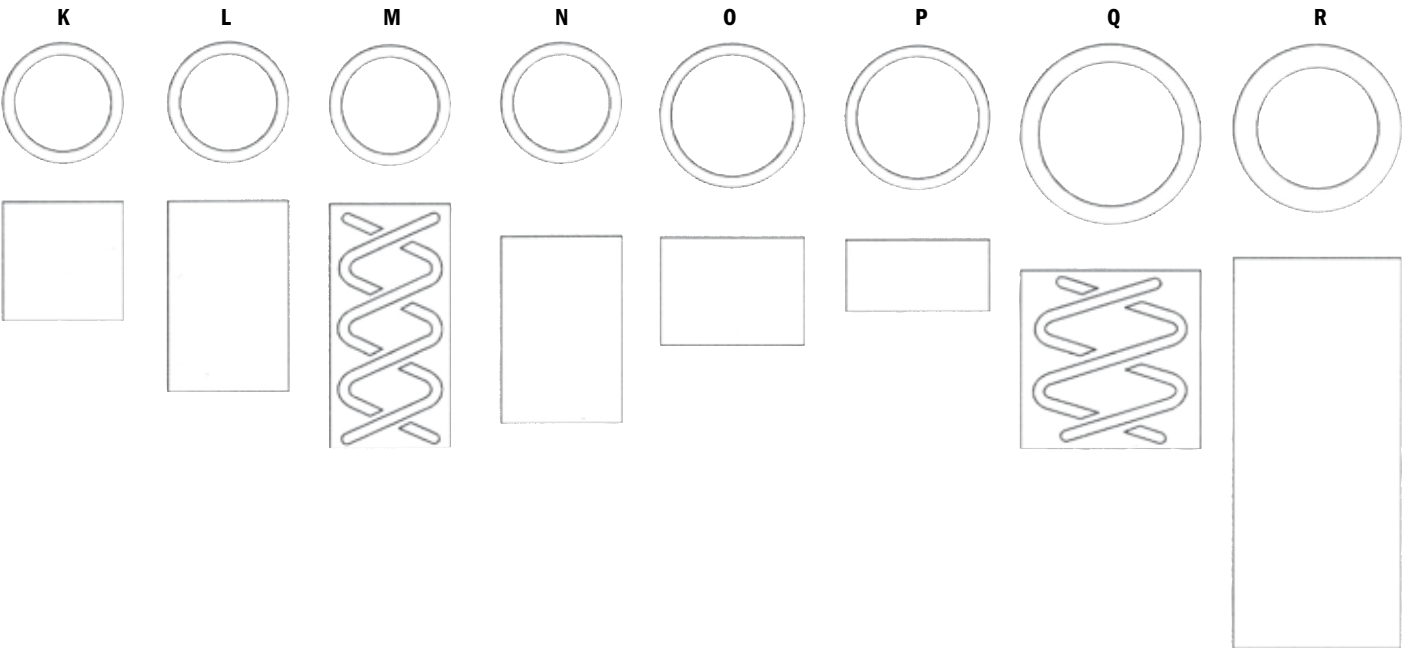
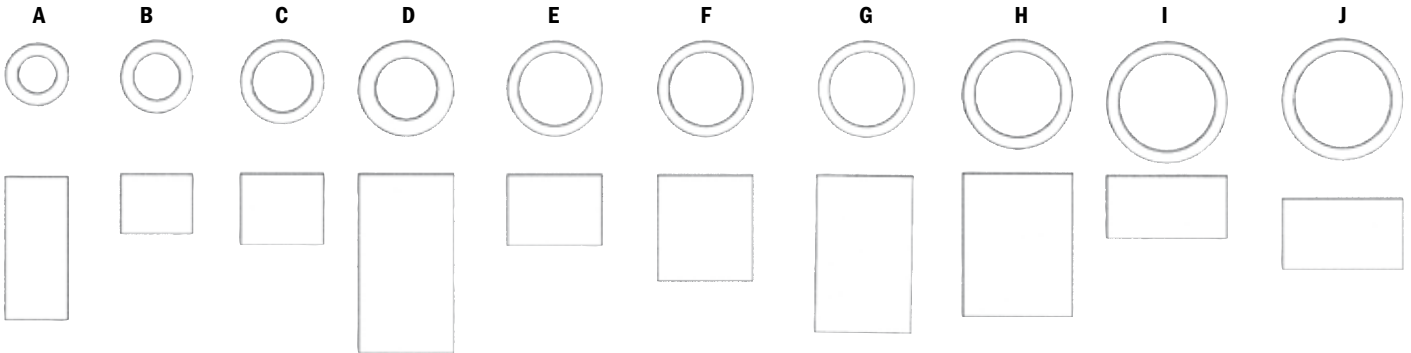

SLEEVE OILITE BEARINGS

	PART	QUANTITY
A	B11421061000BG	Bag of 5
B	B11421045000BG	Bag of 5
C	B12200105000BG	Bag of 5
D	B11421004000BG	Bag of 5
E	B11421053000BG	Bag of 5
F	B11421048000BG	Bag of 5
G	B11421008000BG	Bag of 5
H	B12150255000BG	Bag of 5
I	B11421065000BG	Bag of 5

SLEEVE OILITE BEARINGS - CONTINUED

	PART	QUANTITY
J	B11421110000BG	Bag of 5
K	B11421017000BG	Bag of 5
L	B11421019000BG	Bag of 5
M	B11421058000BG	Bag of 5
N	B12200104000BG	Bag of 5
O	B10421901000BG	Bag of 2
P	B11421109000BG	Bag of 2
Q	B11421041000BG	Bag of 2
R	B12400199000BG	Bag of 2

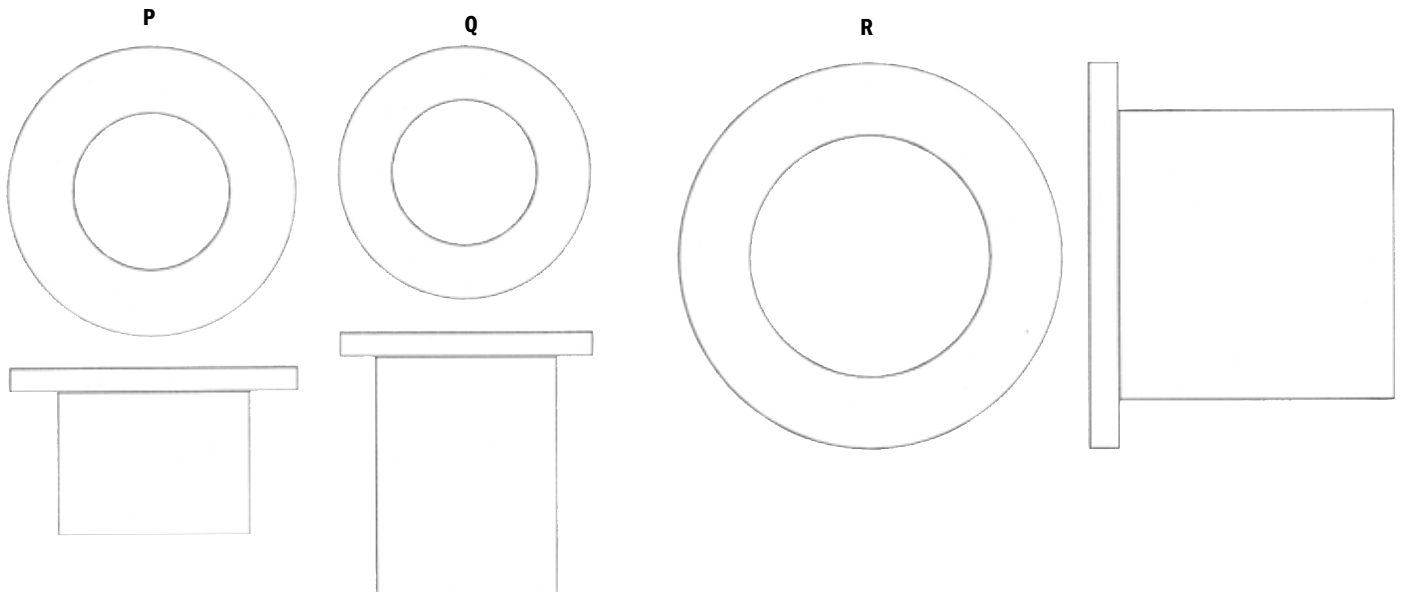
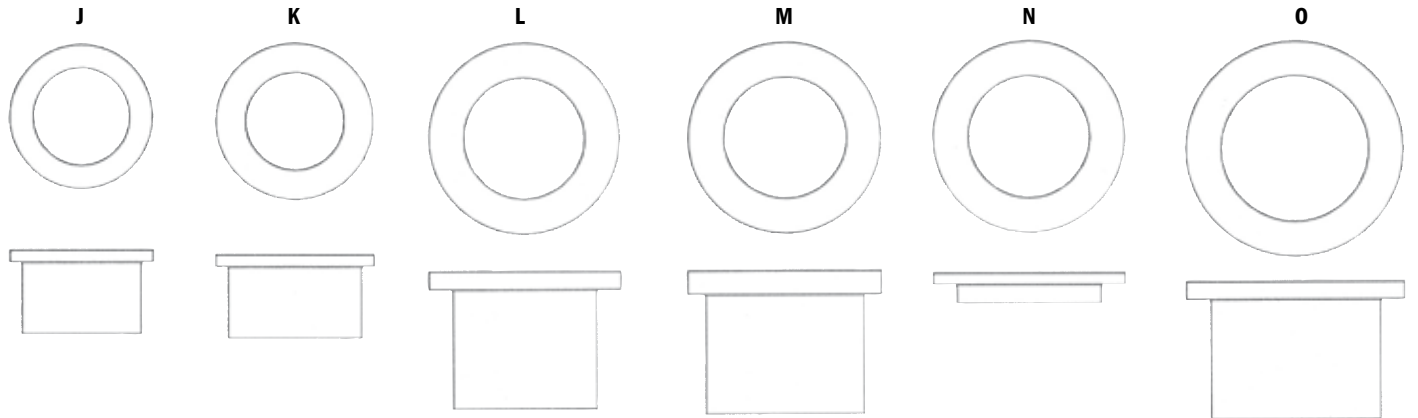
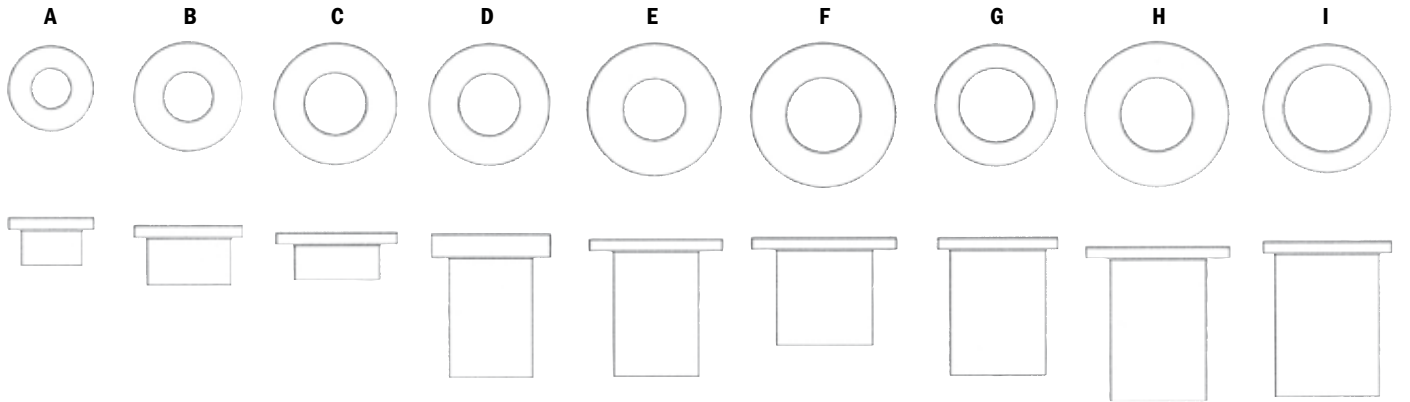

BALL BEARINGS

BALL BEARINGS

	PART	QUANTITY
A	B10430001000	Qty. 1
B	B11413001000	Qty. 1
C	B11430003000	Qty. 1
D	B11430004000	Qty. 1

BALL BEARINGS - CONTINUED

	PART	QUANTITY
E	B11430007000	Qty. 1
F	B11430013000	Qty. 1
G	B11430015000	Qty. 1

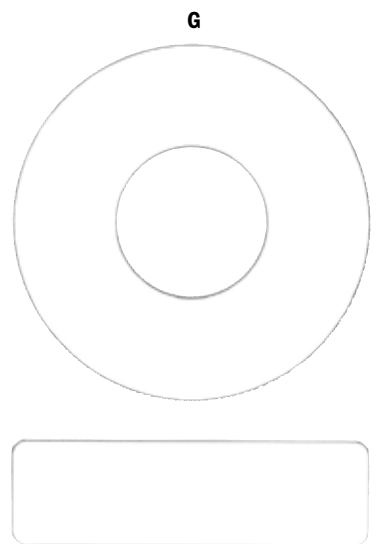
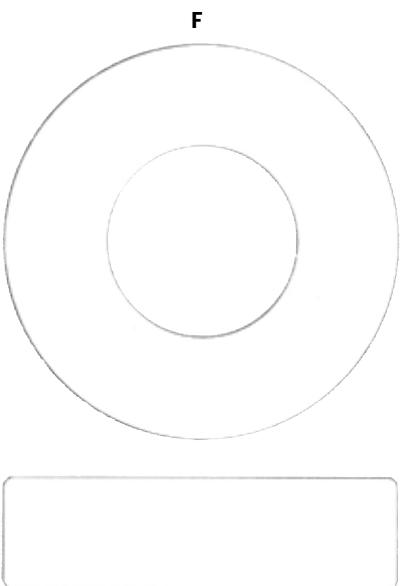
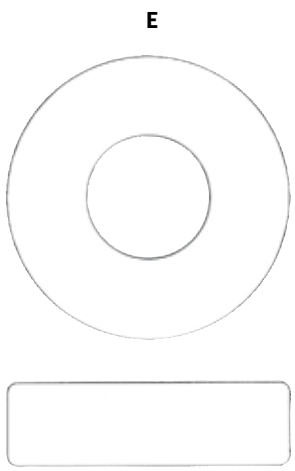
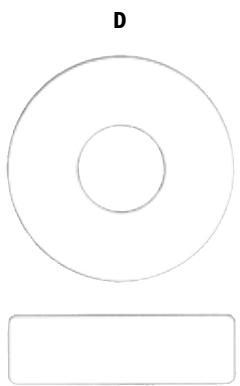
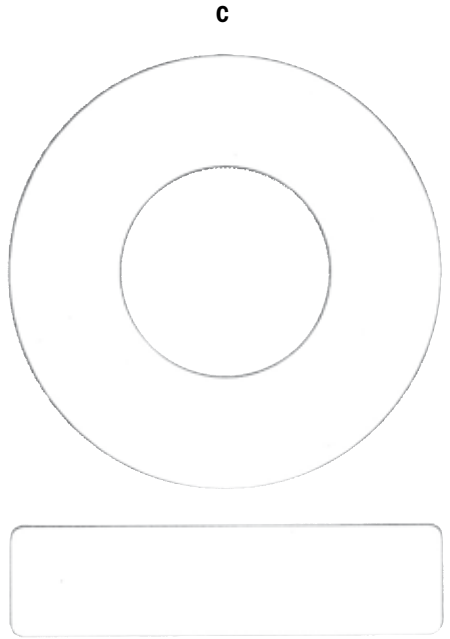
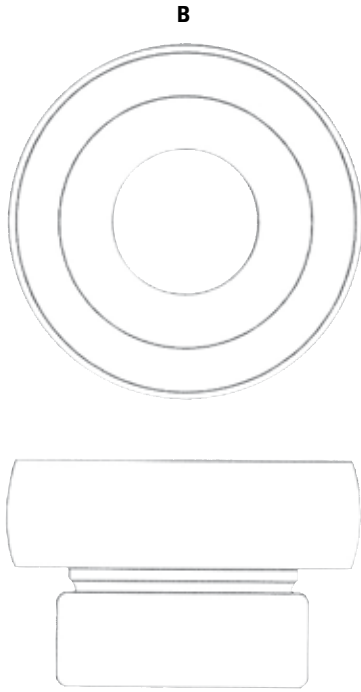
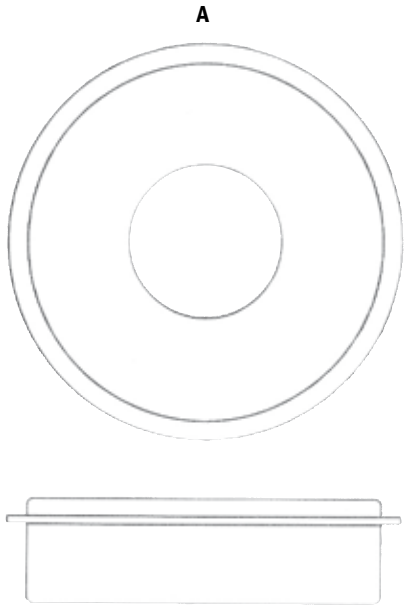

BALL BEARINGS - CONTINUED

PART	QUANTITY
H B11430016000	Qty. 1
I B11430037000	Qty. 1
J B11431006000	Qty. 1
K B11431010000	Qty. 1
L B11432000000	Qty. 1

BALL BEARINGS - CONTINUED

PART	QUANTITY
M B11433000000	Qty. 1
N B11437000000	Qty. 1
O B11450201000	Qty. 1
P B11450301000	Qty. 1

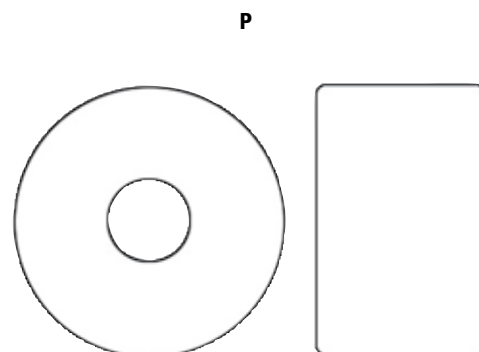
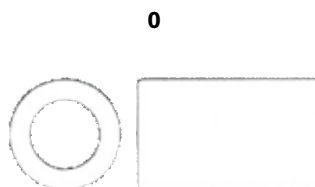
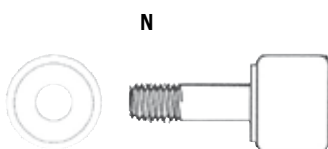
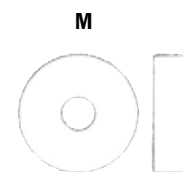
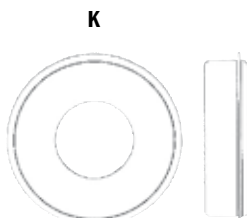
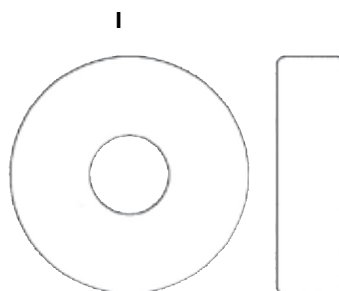
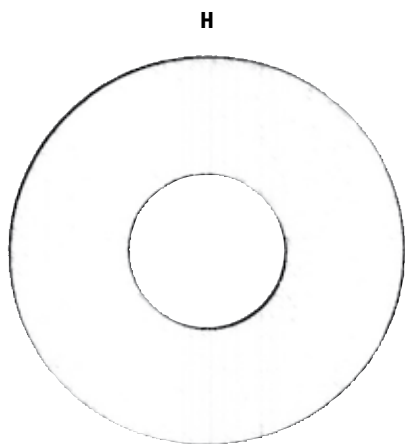

BALL BEARINGS - CONTINUED		
PART		QUANTITY
Q	B11450303000	Qty. 1
R	B11460000000	Qty. 1
S	B11461000000	Qty. 1
T	B11483000000	Qty. 1
U	B11483001000	Qty. 1

BALL BEARINGS - CONTINUED		
PART		QUANTITY
V	B11490001000	Qty. 1
W	B11491000000	Qty. 1
X	B11500001000	Qty. 1
Y	B12862171000	Qty. 1

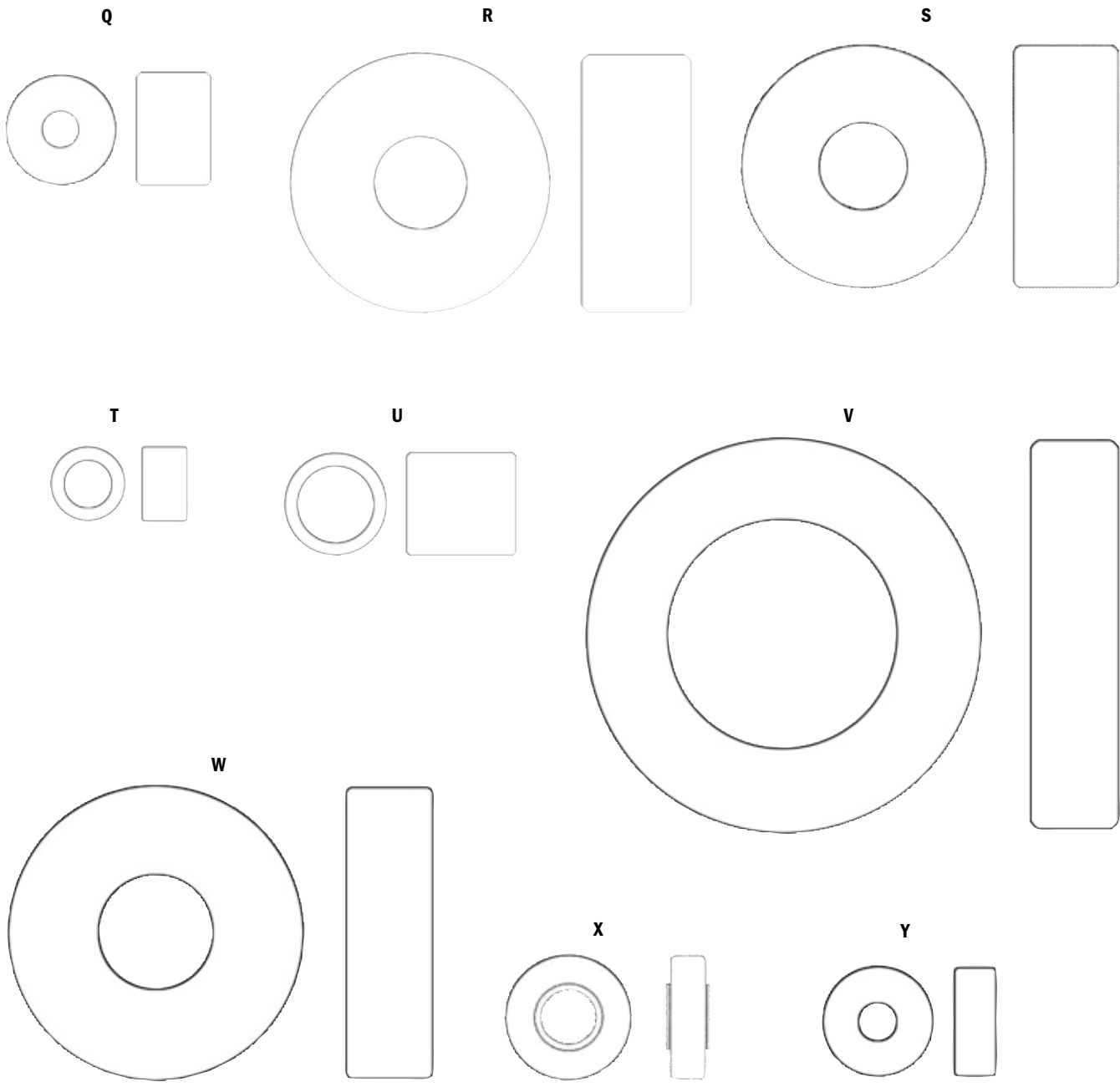

BALL BEARINGS - CONTINUED

	PART	QUANTITY
Z	B11430028000	Qty. 1
AA	B11430042000	Qty. 1
BB	B11430043000	Qty. 1

BALL BEARINGS - CONTINUED

	PART	QUANTITY
CC	B11430045000	Qty. 1
DD	B11431000000	Qty. 1
EE	B11432002000	Qty. 1

Z

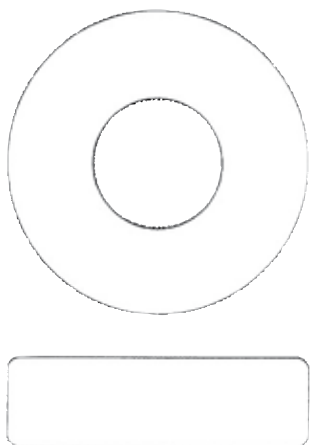

AA

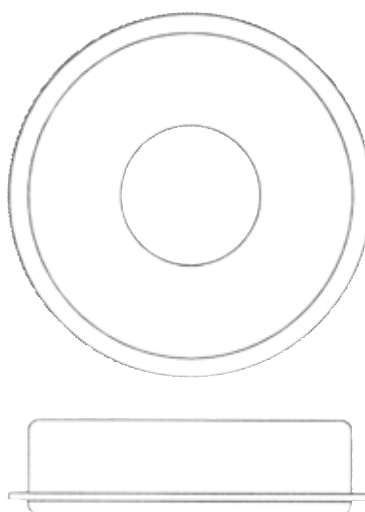

BB



CC

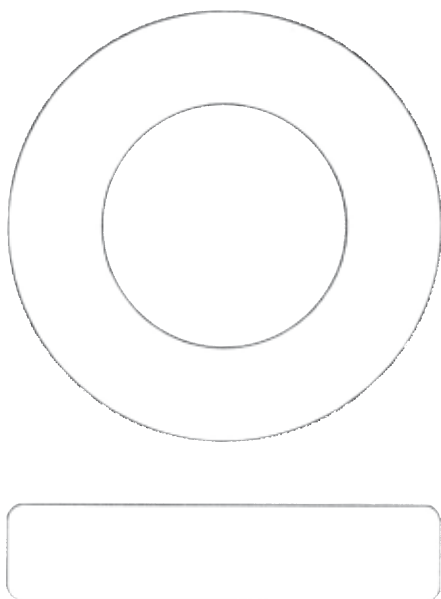

DD

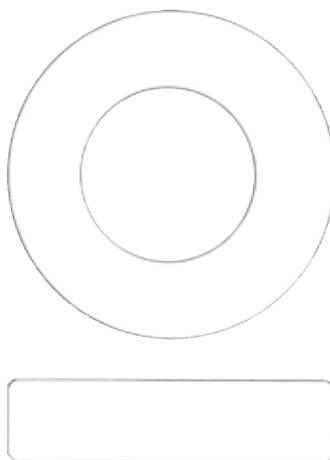

EE

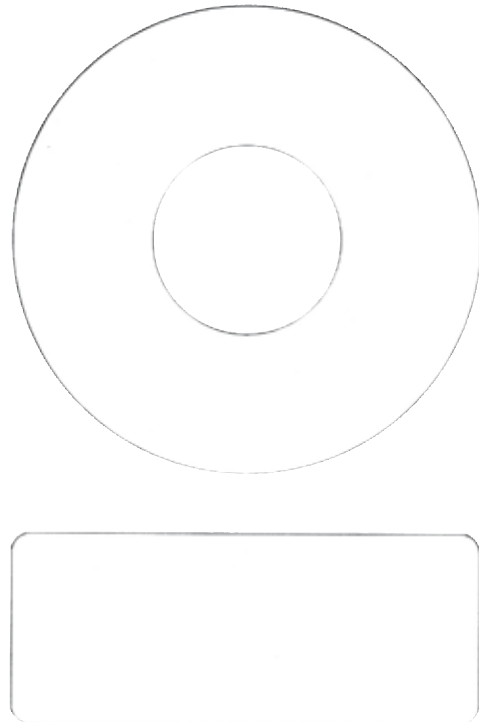

GUIDE ROLLERS

PART	SUB-SECTION	QUANTITY
FF B11430037000	Guide Rollers	Qty. 1

FF

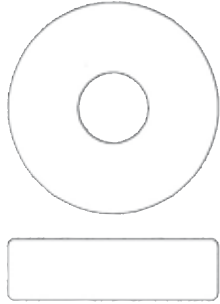

JOGGER ARM

PART	SUB-SECTION	QUANTITY
GG B11450001000	Jogger Arm	Qty. 1

GG

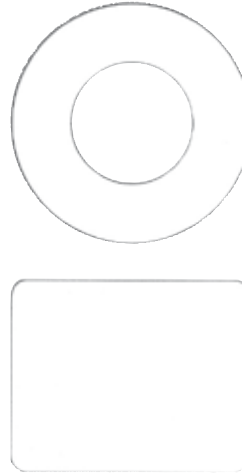

CAM FOLLOWER NEEDLE

PART	SUB-SECTION	QUANTITY
HH B11480001000	Cam Follower Needle	Qty. 1

HH

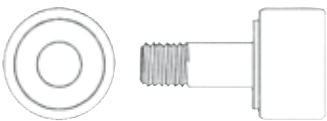

PIN WHEEL GUIDE ROLLER

PART	SUB-SECTION	QUANTITY
II B11430008000	Pin Wheel Guide Roller	Qty. 1

II



TENSION SPRING

PART	QUANTITY
A B12100107000	Qty. 1
B B12100296000	Qty. 1
C B12102105000	Qty. 1

TENSION SPRING - CONTINUED

PART	QUANTITY
D B12150025000	Qty. 1
E B12150070000	Qty. 1
F B12150096000	Qty. 1

A

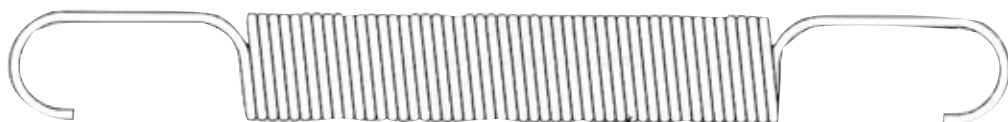

B



C



D

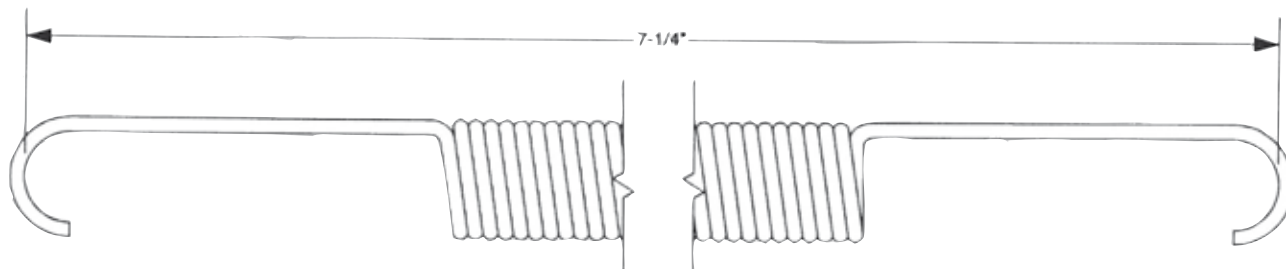

E

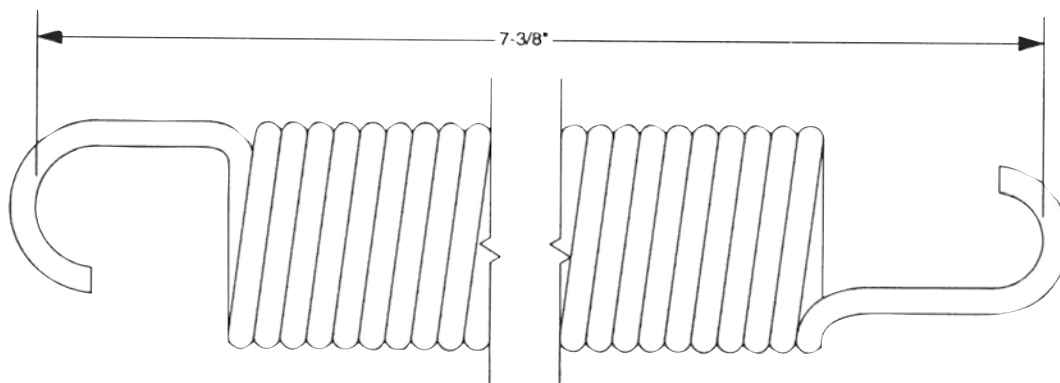

F



TENSION SPRING - CONTINUED		
PART		QUANTITY
G	B12150132000	Qty. 1
H	B12252330000	Qty. 1
I	B12400194000	Qty. 1

TENSION SPRING - CONTINUED		
PART		QUANTITY
L	B12450051000	Qty. 1
M	B12450061000	Qty. 1
N	B12450079000	Qty. 1

G

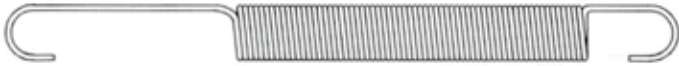

H



I

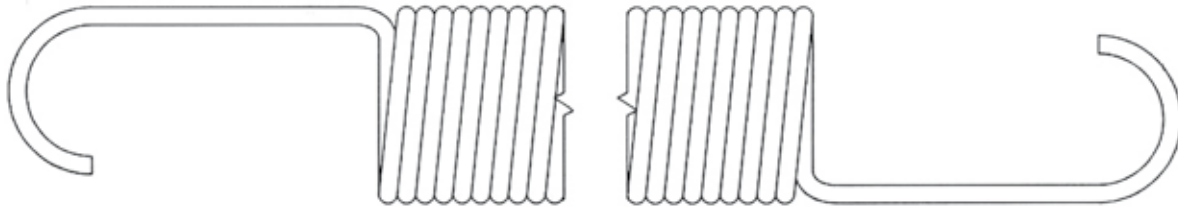

L

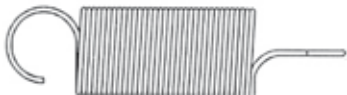

M

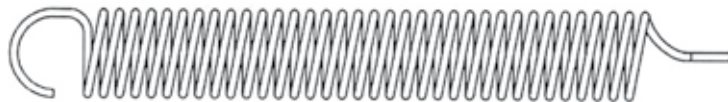

N



PART		QUANTITY
A	B12150087000	Qty. 1
B	B12700041000	Qty. 1

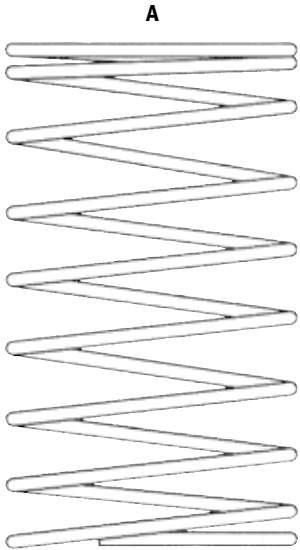

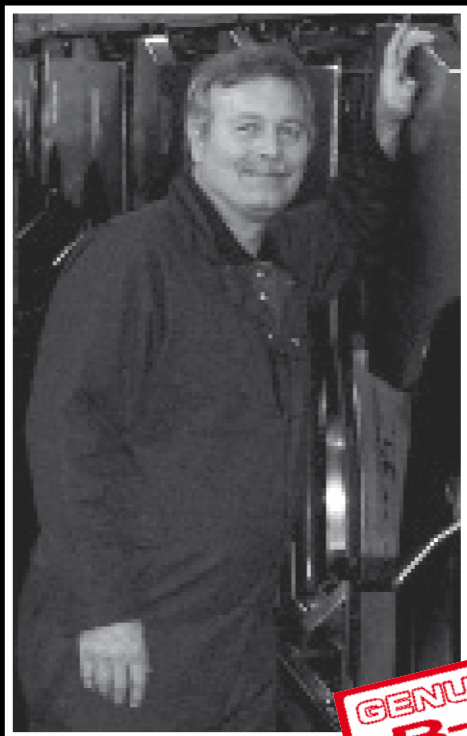

STEVE FEDE

B-2 Parts Specialist



THERE'S MORE THAN ONE WAY TO GET IN TOUCH WITH QubicaAMF.

Making it easy for you to reach QubicaAMF is just as important to us as getting our quality products into your hands.

Contact us via phone, fax, web and e-mail and be served by people whose expertise and helpfulness make it easy for you to do business with QubicaAMF.

- ▼ To order Genuine AMF and B-2 Parts and Supplies, contact your local Genuine AMF or B-2 Distributor
- ▼ To learn more about Genuine AMF and B-2 Parts and Supplies, or to locate a distributor near you, visit www.quibcaamf.com
- ▼ To speak to a live person, call 1-866-460-QAMF (7263)
- ▼ To reach us by fax, dial (804) 730-4464
- ▼ To join in on our interactive Products Forum that provides you with a direct link to discussion among peers worldwide, visit <http://forum.amfproducts.com>
- ▼ Still want to write? Send it to QubicaAMF Worldwide Consumer & Support Products, 8100 AMF Drive, Mechanicsville, VA 23111, USA



WORLDWIDE HEADQUARTERS

8100 AMF Drive - Mechanicsville, VA 23111 - USA - Tel. (804) 569-1000 - Fax: (804) 559-8650 - Toll free 1-866-460-QAMF (7263)

EUROPEAN HEADQUARTERS

Via della Croce Coperta, 15 - 40128 Bologna - Italy - Tel. +39 051.4192.611 - Fax +39 051.4192.602

www.qubicaamf.com - info@qubicaamf.com